



Approved for Digital
Weigh Indicator

Digital Weighing Controller SI 4100

Instruction Manual





CONTENTS



1. Before Installation	-----	3 page
2. Introduction	-----	4 page
3. Specification	-----	5 page
4. Installation	-----	11page
4-1. External Dimension & Cutting Size	-----	11 page
4-2. Load Cell Installation	-----	12 page
4-3. Installation Components	-----	12 page
5. Set-up	-----	14 page
5-1. Calibration	-----	14 page
5-2. TEST Weight Calibration Mode	-----	14 page
5-3. Simulation Calibration Mode(Without Test Weight)	-----	17 page
5-4. Set-up	-----	20 page
5-5. F-Function	-----	21 page
6. Interface	-----	42 page
6-1. Serial Interface (RS-232C)	-----	42page
6-2. Current Loop Interface	-----	45page
6-3. Print Interface (Centronics Parallel Interface)	-----	46page
6-4. Analog Output Interface (0~10V)	-----	47page
6-5. Analog Output Interface (4~20mA)	-----	49page
6-6. Serial Interface (RS-232C / 422 / 485)	-----	50page
6-7. BCD INPUT	-----	51page
6-8. BCD OOUTPUT	-----	52page
6-9. Command Mode	-----	53page
7. Error & Treatment	-----	56page
7-1. Load Cell Installation	-----	56page
7-2. Calibration Process	-----	56page
7-3. Indicator Error & Treatment	-----	57page
7-4. Indicator Test Mode	-----	58page
Warrantee Certification	-----	59page

1. BEFORE INSTALLATION

1-1. Caution / Warning Marks

 <i>Warning</i>	This mark warns the possibility to arrive death or serious injury in case of wrongly used.
 <i>Caution</i>	This mark cautions the possibility to arrive serious human body injury or product lose in case of wrongly used.

1-2. Other Marks

	Warning for Electric Shock or Damage. Please do not touch by hand
	Protective Ground(Earth) terminal
	Prohibition of Operation process

1-3. Copy Rights

- 1).All Right and Authority for this Manual is belonged to Sewhacnm Co.,Ltd.
- 2).Any kinds of copy or distribution without Sewhacnm Co.,Ltd's permission will be prohibited.

1-4. Inquiries

If you have any kinds of inquiries for this model, please contact with your local agent or Head Office.

Head Office : Sewhacnm Co.,Ltd.

Website : www.sewhacnm.co.kr

Email : sales@sewhacnm.co.kr

2. INTRODUCTION

2-1. Introduction

Thank you for your choice of this “SI 4100” Industrial Digital Weighing Controller.

This “SI 4100” model is advanced model of “SI 4100”, with powerful communication performance.

With 2ports serial port communication and precise weighing control system, you can upgrade your weighing process.

This “SI 4100” Weighing Controller has various kinds of “Weighing Mode”, like Limit, Packer, and Check weighing Mode, so you can apply various kinds of weighing applications.

Please review this instruction Manual and learn more about information about “SI 4100”.

Enjoy your process efficiency with “SI 4100” Weighing Controller.

2-2. Cautions



- 1) Don't drop on the ground or avoid serious external damage on item.
- 2) Don't install under sunshine or heavy vibrated condition.
- 3) Don't install place where high voltage or heavy electric noise condition.
- 4) When you connect with other devices, please turn off the power of item.
- 5) Avoid from water damage.
- 6) For the improvement of function or performance, we can change item specification without prior notice or permission.
- 7) Item's performance will be up-dated continuously base on previous version's performance.
- 8) If the equipment is used in a manner not specified by the manufacturer, the protection provided by the equipment may be impaired.

2-3. Grounding

Ground the earthing terminal to protect from being affected by intensive electrical disturbances.

As the indicator has a 3-pole plug, grounding can be taken from the plug.

2-4. Features

- 1) All Modules and Option Cards are isolated to maximize accuracy and performance.
- 2) External input terminal inside.(4pcs:Can be set by F11 mode)
- 3) By using “Photo-Coupler” on each module(Option, Analog board, In/Out), we improved “Impedance problem”, “Isolation ability among inputs”, “Leading power problem”, and “Noise covering function”.
- 4) Data back-up function, when the sudden power off
- 5) Set value Error check function added – If each set value is not correct for selected “weighing mode”, “E” will be displayed and will not operate until correct set value input.
- 6) Polycarbonate film panel, strong against dust and water
- 7) 2port Serial Interface - RS-232C (Com. Port1) is standard installed.
- 8) Weight Unit selection Function added. (“g”, “kg”, “t” selectable – F40)
- 9) Variable options(Order in advance, Refer Chapter 5. Interface)

3. SPECIFICATION

3-1. Analog Input & A/D Conversion

Input Sensitivity	0.3 μ V / Digit
Load Cell Excitation	DC 10V (- 5V ~ + 5V)
Max Input Signal	Max3.2mV/V
Temperature Coefficient	[Zero] \pm 16PPM/ $^{\circ}$ C [Span] \pm 3.5PPM/ $^{\circ}$ C
Input Noise	\pm 0.3 μ V P.P
Input Impedance	Over 10M Ω
A/D Conversion Method	Sigma-Delta
A/D Resolution(Internal)	520,000 Count(19bit)
A/D Sampling Rate	Max 500times / Sec
Non-Linearity	0.005% FS
Display Resolution(External)	1/20,000

3-2. Digital Part

Display	Parts	Specification
Display	Main Display	7Segments, 7digits VFD green Color Size :12.7(H) \times 7.0(W)mm
	Min. Division	\times 1, \times 2, \times 5, \times 10, \times 20, \times 50
	Max display value	+999,950
	Under Zero value	"-" (Minus display)
Status lamp	Steady, Zero, Tare, Run, Hold, Print, Comm.	" \blacktriangledown " Condition display Lamp
	SP1, SP2, SP3, SP4 , kg, g, t	Green LED Display(3 ϕ)
Key	Number, Function, CAL. Lock Key	Number Key(10), Function(5), CAL. Lock keys (1pcs)

3-3. General Specification

Power Supply	AC110/220V, 50/60Hz, 30VA
Fuse	T 0.5 A L 250V
Operating Temperature Range	-10 $^{\circ}$ C ~ 40 $^{\circ}$ C
Operating Humidity Range	Under 85% Rh (non-condensing)
External Dimension	200mm(W) \times 105mm(H) \times 165mm(L)
Net Weight(kg)	About 2.3kg
Gross Weight(kg)	About 3.0kg

※ AC 110V, Power supply is an optional before ex-factory.

3-4. Option Card

Option No.1	Printer Interface : Centronics Parallel
Option No.2	Analog Output (0~10V or 0~5V)
Option No.3	Analog Output (4~20mA)
Option No.4	Serial Interface : RS-232C / 422 / 485
Option No.5	BCD INPUT (P/N change purpose)
Option No.6	BCD Output
Option No.7	Ethernet

※ Serial Interface (RS-232C) or Current Loop is Standard installed.

In the Optional Serial port, there is no Current Loop function.



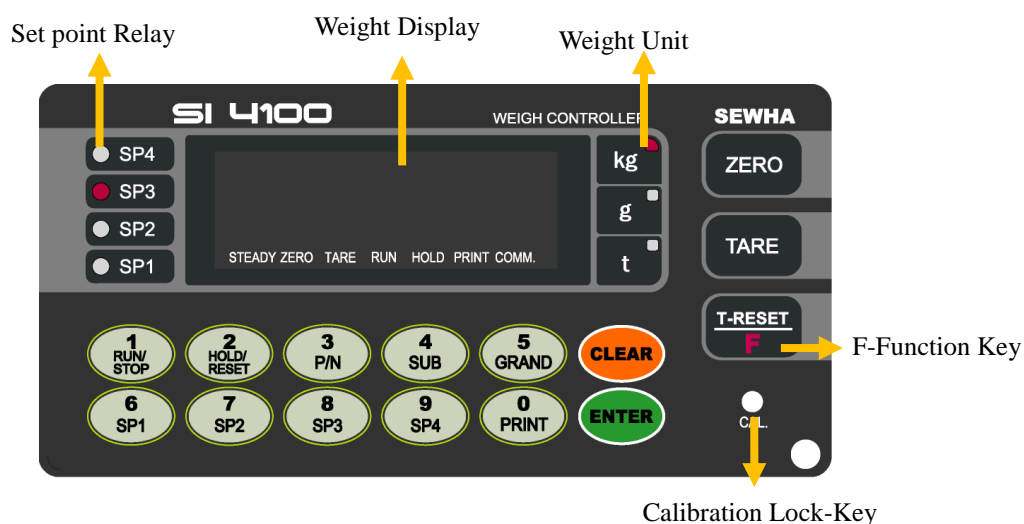



3-5. Front Panel (Display / Key Pad)









3-5-1. Status Lamp (ANNUNCIATORS) : “▼” Lamp is “ON”.

Steady	When the weight is Steady, “▼” Lamp is turn on.
Zero	When the current weight is Zero, “▼” Lamp is turn on. (Displayed weight is Zero, “▼” Lamp is turn on.)
Tare	Tare function is set, “▼” Lamp is turn on. (Tare Reset → “▼” Lamp is turn off.)
Run	Weighing Batch is started, “▼” Lamp is turn on. (Under F21-01, 05, 06 setting)
Hold	Hold function is sec, “▼” Lamp is turn on. (Hold Reset → “▼” Lamp is turn on.)
Print	When print key input, “▼” Lamp is turn on. (Under F38-00 setting, option port : F68-00)
Comm.	When indicator transfers or receives data from other devices, “▼” Lamp is turn on. If the “▼” is off although there is some data transference, please check communication setting.





3-5-2. Key Operation

	<p>Make Weight value as Zero.</p> <p>Under F08, you can set the Zero key operation range, as 2%, or 5%, or 10%, or 20% of Max Capacity.</p> <p>※ Under “Tare” key input, Zero key will not be activate within operation range</p>
	<p>Make Weight value as Zero, including Tare Weight.</p> <p>Under F09, you can set the Tare key operation range, as 10%, 20%, 50%, or 100% of Max Capacity.</p> <p>※ Whenever pressing “Tare” key, you can set the Tare continuously.</p>
	<p>TARE RESET</p> <p>1. Remove the Set TARE function.</p> <p>If you press this key, TARE set value will be removed and display gross weight.</p> <p>FUNCTION KEY</p> <p>1. “F-TEST” Mode Entrance : Press “F” key for 5sec.</p> <p>2. Under “F-function Mode”, Move to next Function or move to certain function No.(Press function No. and press “F” key)</p> <p>3. Function key (Refer “Function keys”)</p>
	<p>To START or STOP weighing process.</p> <p>First input, SI 4100 Controller Starts weighing process, and Second input, SI 4100 Controller stops weighing process.</p> <p>※ This function will be activated under F21- setting, only.</p>
	<p>Hold the Weight display when indicator detects “Peak Hold”, or “Sample Hold”.</p> <p>First input, SI 4100 Controller takes “Hold” point, and Second input, SI 4100 Controller remove “Hold” function.</p> <p>※ You can select “Hold” function on F10.</p>
	<p>You can set each weighing process as a certain P/N.</p> <p>Each weighing process will be saved with Sp1, Sp2, Sp3, Sp4 set values.(Max 50 kinds of P/N you can set)</p> <p>And you can call certain P/N with each set value.</p> <p>P/N save : Select P/N and input Sp1, Sp2, Sp3, Sp4 values and save.</p> <p>P/N call : P/N + Number key + Enter</p>

	<p>Under Print installation, you can print out the “Sub-total data” of current P/N. Printed Data : Accumulated count and weight of current P/N.</p>
	<p>Under Print installation, you can print out the “Grand-total data” of current P/N. Printed Data : Accumulated count and weight of All P/N.</p>
	<p>Sp1 set value setting or Check Value setting : Press this key → set Sp1 value with No. keys. → Press Enter and save new set value. Check set value : Press this key → Sp1 value will be display during 5sec.</p>
	<p>Sp2 set value setting or Check Value setting : Press this key → set Sp2 value with No. keys. → Press Enter and save new set value. Check set value : Press this key → Sp2 value will be display during 5sec.</p>
	<p>Sp3 set value setting or Check Value setting : Press this key → set Sp3 value with No. keys. → Press Enter and save new set value. Check set value : Press this key → Sp3 value will be display during 5sec.</p>
	<p>Sp4 set value setting or Check Value setting : Press this key → set Sp4 value with No. keys. → Press Enter and save new set value. Check set value : Press this key → Sp4 value will be display during 5sec.</p>
	<p>1. Manual Print Whenever press this key, you can print out.</p> <p>2. Calibration mode</p> <ul style="list-style-type: none"> - Digit setting Whenever pressing “0”key, digit will be change 1, 2, 5, 10, and 50. - Decimal point position Whenever pressing “0”key, decimal point will be change. <p>※Decimal Point set will be done in the calibration mode.</p>

	<ol style="list-style-type: none"> 1. Modify the set value during setting process. 2. Calibration mode <ul style="list-style-type: none"> - Move back to previous step. 3. F-function setting mode <ul style="list-style-type: none"> - Change F-function No. F-function no.(number key) + Clear → directly move to that F-function 4. Function key : Sub-total, Grand-total manual delete.
	<ol style="list-style-type: none"> 1. Save set value during setting process. 2. Calibration mode <ul style="list-style-type: none"> - Save current setting and move to next step. 3. F-Function mode <ul style="list-style-type: none"> - Save current F-function setting, and move to next F-function
	<p>Press 1time to enter “Calibration” mode.</p>

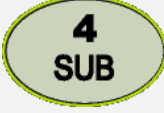
※ Function Keys (Combined Key functions)

Function Key		Contents
		<p>Manual Discharge</p> <p>Remove remained material with manual discharge function.</p> <p>All gates will be opened(SP1,Sp2,SP3,SP4 relay output)</p> <p>※ Only activated under “F28-01”setting.</p>
		<p>Delete current P/N’s accumulated weighing count and weight</p> <p>(If you set F44-01, the data will be automatically deleted after “Sub-Total Print).</p>
		<p>Delete all P/Ns’ accumulated weighing count and weight</p> <p>(If you set F44-01, the data will be automatically deleted after “Grand-Total Print).</p>

3-6. Rear Panel



① POWER AC IN

- Power switch : Power on/off switch.

Use this on/off switch when power need to be disconnected.

- Fuse : AC250V / 0.5A , ϕ 5.25 , 20mm.

- AC IN : Available Input AC 110V / 220V.

※ The standard power supply is AC 220V(Fixed when ex-warehouse), if you want to have AC 110V, please inform in advance.

② Option Card 1

③ Option Card 2

※ Option Card Connector installed for Optional Interface or Output.

(Printer I/F, Analog out, RS-422/485, or RS-232C(two port))

④ LOAD CELL Connector (N16-05)

⑤ SERIAL I/F

“RS-232C” or “CURRENT LOOP”(9Pin, D-Type Female) are built-in as standard

⑥ External Input : External control input for wired remote control.

Refer to F-Function F11 to select desired function mode.

Input signal Optical-Isolator

⑦ Relay Output Terminal : Set point(SP1, SP2, SP3, SP4) and Finish, Empty relay output.

(Refer “F21” setting.)

4. INSTALLATION

4-1. External Dimension & Cutting Size

(External Dimension) (unit : mm)

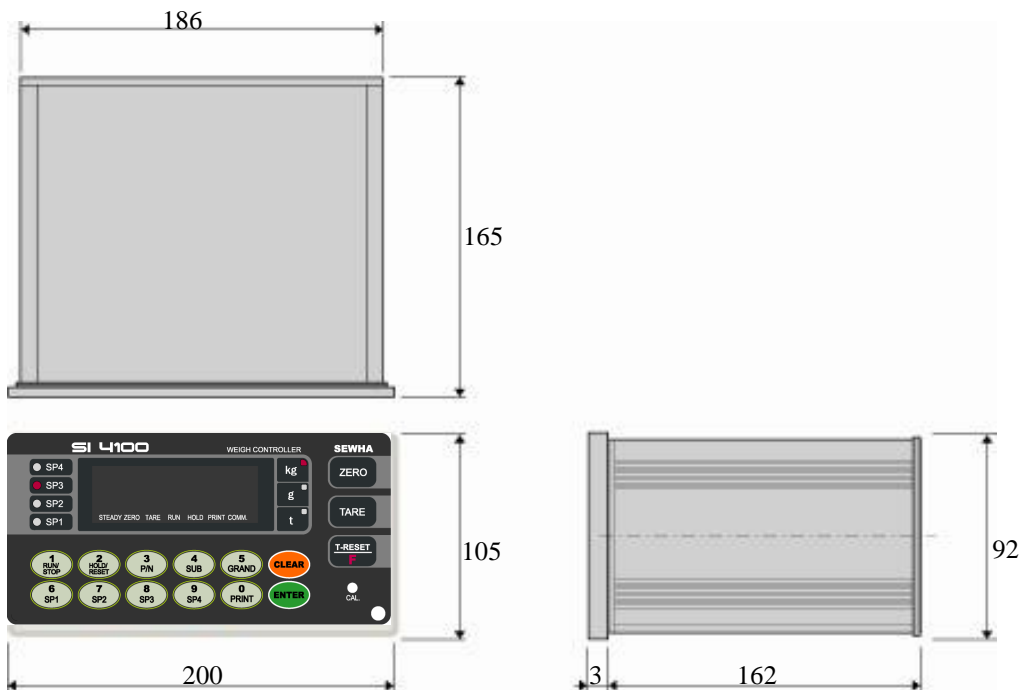

(Cutting Size) (Unit : mm)

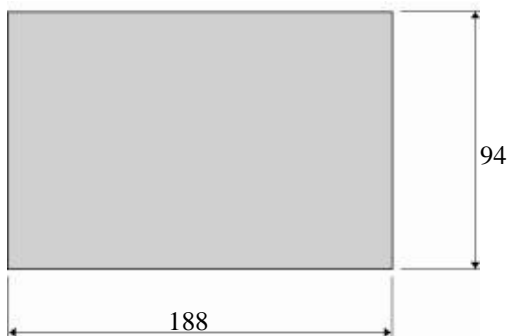

4-2. Installation Components

※ Only properly rated power cable should be used.

Power Cable	Communication Connector(D-SUB 9P)	Load-cell Cable
		

4-3. Load Cell Installation

4-3-1. Load Cell Connector Specification

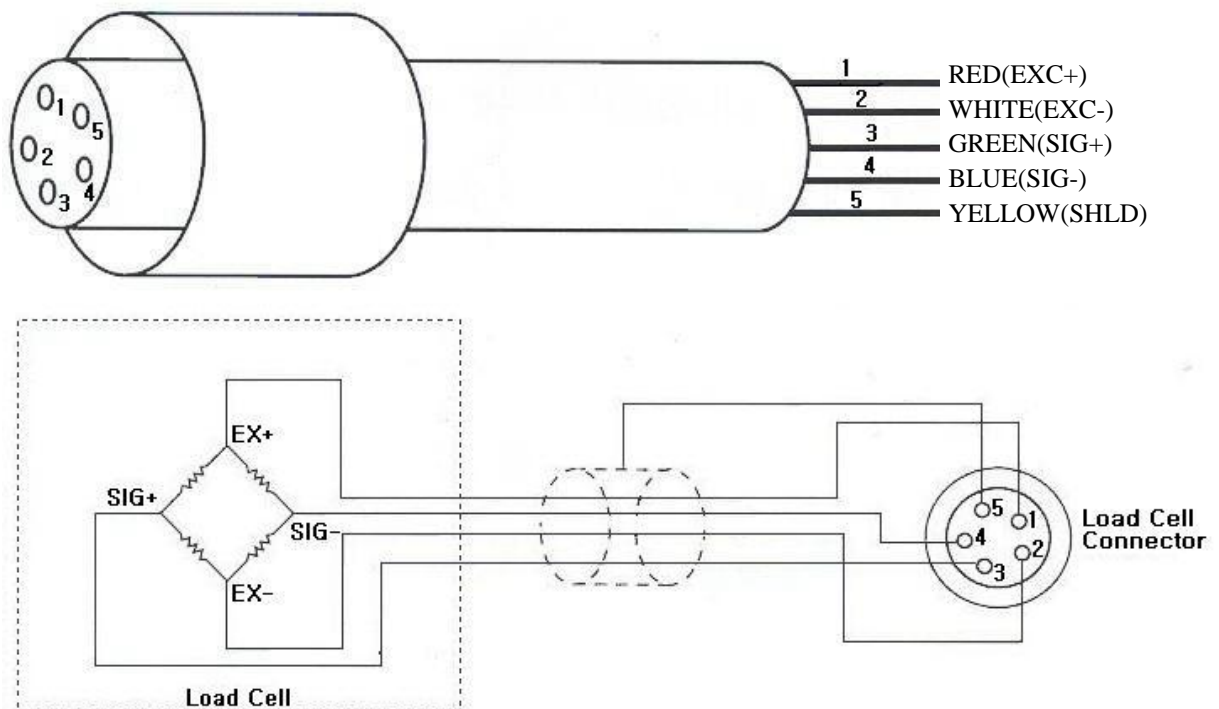

4-3-2. Load Cell Installation

- 1) You can connect Max 8pcs of same capacity Load cells at once. (350Ω)
- 2) You have to make horizontal balance on the ground.
- 3) If you install more than 2pcs of Load cells, use Summing box and adjust output signal difference as minimum. It can make wrong weighing process caused by each load cell's variation.
- 4) If there is some temperature difference around Load cell, it can cause wrong weight measurement.
- 5) Don't do Welding job or Arc discharge around installation place. But, there is no choice, please disconnect power cable and Load cell cable.
- 6) If you measure static electricity material, please make earth between down part and up part of Load cell.

4-2-3. Formula to plan the precise weighing system



This “SI 4100” weighing controller’s Max input sensitivity is $0.2\mu V / \text{Digit}$.

And for precise weighing system, the following formula must be satisfied.

Caution : “Input sensitivity” means Min. output voltage variation of weighing part to change 1digit.

So, please do not make large input voltage to make reliable weighing system.

Single Load cell use	$0.2\mu V \leq \frac{E \times B \times D}{A}$	A : Load cell capacity(kg) B : Load cell Voltage(mV) D : Digit
Plural Load cells use	$0.2\mu V \leq \frac{E \times B \times D}{A \times N}$	E : affirmation Voltage of Load cell N : Number of Load cell

Example1.)

Number of Load cell : 1pcs

Load cell capacity : 500kg

Load cell Related output : 2mV/V

Division : 0.05kg

Affirmation Voltage of Load cell : 5,000mV

Max Capacity of Weighing System : 300kg

Then, estimation result for this weighing system with formula,

$$\frac{5000 \times 2 \times 0.05}{500} = 1 \geq 0.2\mu V$$

The calculated value is larger than $0.2\mu V$,
so this system has no problem.

Example2.)

Number of Load cell : 4pcs

Load cell capacity : 500kg

Load cell Voltage : 2mV/V

Digit : 0.10kg

Affirmation Voltage of Load cell : 5,000mV

Max Capacity of Weighing System : 1,000kg

Then, estimation result for this weighing system with formula,

$$\frac{5000 \times 2 \times 0.10}{500 \times 4} = 0.5 \geq 0.2\mu V$$

The calculated value is larger than $0.2\mu V$,
so this system has no problem.

※ According to “Resolution” or “Capacity”, it might not be calibrated like calculation.

5. SET-UP

5-1. Calibration

Calibration is the process of adjusting weight balance between “Real weight” on the load cell and “Displayed weight of Indicator”. When you replace LOAD CELL or Indicator, you have to do Calibration process once again

5-2. Test Weight Calibration Mode (Using Test weight)

Prepare the test weight as at least 10% of your weighing scale’s max capacity.

Remove “CAL-BOLT” on the indicator’s front panel and press “CAL - LOCK S/W” inside.

※ Remark: If “P-W” is displayed, you should input the pass word to start calibration mode.



1. At normal mode, remove “CAL-BOLT” on the Front panel

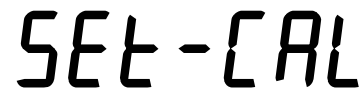

2. And press “CAL - LOCK S/W” inside.

Check the “SET-CAL. message on display.



※ To save the each step, press  key, and for the cancel or move back, press  key.

3. If you press  key, Calibration Mode starts.

After displaying “C999999”,



4. Input the max capacity of your weighing scale,

And press  key.

Ex) Load cell CAPA : 20kg, division : 0.001 → Input 20000





5. Define the optimal position of decimal point.

Whenever you press  key, the location of decimal point will be changed.

Ex) Load Cell CAPA : 20kg, division : 0.001kg → input 20.000



6. Press  key to save and move to next step.



7. Define the optimal Digit/Division value of weighing measurement.

Whenever you press  key, the Digit/Division value will be changed in order of “1 → 2 → 5 → 10 → 20 → 50” .

Ex) Load cell CAPA : 20kg, division : 0.001 → Input division “1”



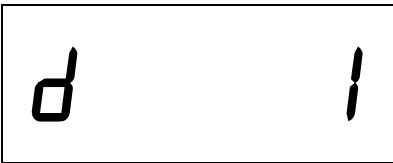

8. press  key to save the Digit/Division value and move to next step





※ **Caution** : (Division value /Max capacity value) cannot over 1/20,000.

If the division is so small compare with max capacity, Error message “ Err 01 “ will be displayed and move back to “CAPA” step again.

9. When you press  key, the indicator starts the dead process to find “Zero” span.

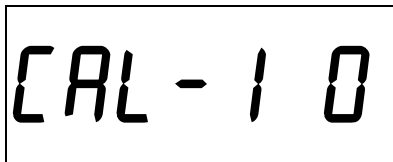

10. Indicator will search “DEAD weight” during 5seconds.
After find optimal “Zero” span , step is automatically
Moves to next.



※ **Caution**: At this step, if there is some force or vibration on weighing scale, and unstable condition will be continued, “ErrorA” will be display, and “DEAD value” will not be calculated.



Please remove all the force or vibration and process it again.

11. Span Calibration mode start.



12. Input the weight of your “Test weight”. And press  key.

Ex) Load Cell CAPA : 20kg, division 0.001

→ Use test weight which is at least 10% of

max CAPA(20kg) = minimum 2kg of test weight is needed.

→ Input test weight 2.000 to indicator.



13. When “UP” is displayed, load your test weight on the scale (weigh bridge) Ex) Load Cell CAPA : 20kg, division 0.001



14. And press  key.

→ Do not remove the test weight from weigh bridge.



15. Indicator will calculate span value during 5sec.

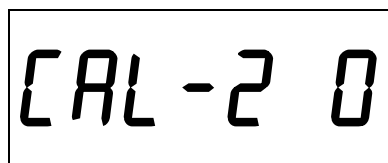

16. After finish calculation, span value will be displayed.

Please remove the test weight from weigh bridge.

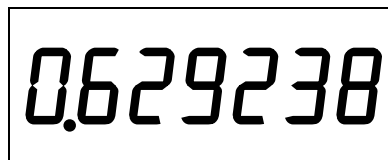

※ **Caution** : The “Test Weight’s value” must be at least **10%** Max capacity of weighing scale.



“at least 10%” means to guarantee precise weighing process you have to make standard with at least 10% of the max capacity weight.

We programmed the calibration will not be done, when you load less than 10% of the max capacity.

17. Press  key to save all calibration process.

After then it resets automatically.

Now, fasten the Calibration Bolt on the front panel.



5-3. Simulation Calibration Mode (Calibrate without Test weight)

Through this “Simulation Calibration Mode” you can do simple calibration process without Test weight.

This calibration mode uses “Load cells’ max capacity” and “Rated output value(mV)”.

Simulation calibration’s degree of accuracy is lower than test weight calibration.

By simulation calibration’s characteristic, measured weight can be different with actual weight, according to load cell’s actual output.

1. At normal mode, remove “CAL-BOLT” on the Front panel



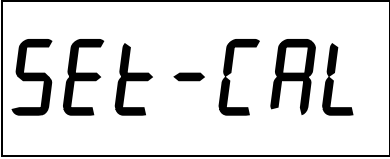

2. And press “CAL - LOCK S/W” inside.
Check the “SET-CAL. Message on display.





3. Press  key, to start Simulation Calibration Mode

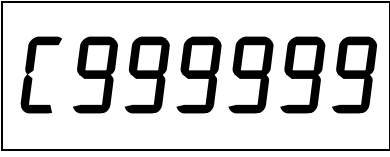

※ To save the each step, press  key, for the cancel or move back, press  key.

4. Press  key to enter calibration mode.
After “CAPA” is displayed, Check the max Capacity of your load cell.
(Refer the label on the load cell, or test report.)



5. After input max capacity of your load cell (at the label),
press  key
Ex) Load cell CAPA : 30kg, division : 0.01 → Input 3000

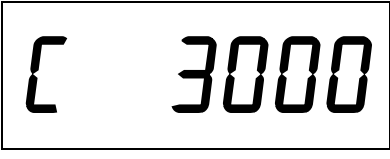

Tip In case of multiple pieces of load cells are installed, make sum of each load cell’s capacity and make setting with max capacity. EX) There are 4pcs of load cells, and each load cell’s Max capa is 1,000kg.
Then, total Max Capacity will be 4,000kg(1,000 x 4) and you have to input 4,000.

6. Define the optimal position or decimal point

Whenever you press  key, the location of decimal point will be changed.

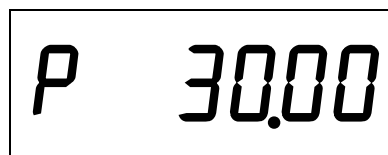

7. Press  key to save Digit / Decimal point and move to next step.

Ex) Load cell CAPA : 30kg, division : 0.01 → Input 30.00



8. Define the optimal Digit/Division value of weighing measurement.

Whenever you press  key, the Digit/Division value will be changed in order of “1 → 2 → 5 → 10 → 20 → 50” .

Ex) Load cell CAPA : 30kg, division : 0.01 → Input division “1”



9. press  key to save the Digit/Division value and move to next step.

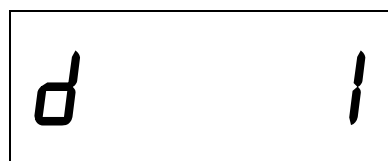

 **※ Caution : (Division value /Max capacity value) cannot over 1/20,000.**
If the division is so small compare with max capacity, Error message “ Err 01 “ will be displayed and move back to “CAPA” mode again.

10. Under this step, measure the “DEAD Weight of Weighing Scale

When you press  key, the indicator starts the dead process to find “Zero” span.



11. Indicator will search “DEAD weight” during 5seconds.

After find optimal “Zero” span , step is automatically Moves to next.

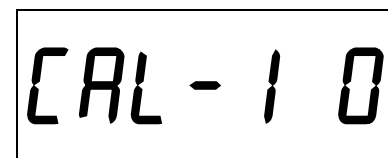

12. At this step input Max Output rate(mV) of load cell.

CELLOUT

13. Input Load cell Output Rate(mV/V) (refer the load cell label)

Ex) Load cell Related output : 1.989 mV/V

0 1.98900



※ **Caution** : Due to some variation between “**Stated output rate**” and “**Real Output rate**” of load cell, there might be some weight difference after finishing calibration.

If you want to make more precise weighing process, please measure real output rate of load cell and input the measured value. Then the weight measurement will be more precise than before.

14. After inputting R.O. value, press  key.
Calculated “Span value” will be displayed.

0.087234

15. Press  key to save all calibration process and fasten the Calibration Bolt.

End



※ **Caution** : To process “Simulation Calibration” process, All indicator has its’ own standard value of 2mV gap. So, if you replaced analogue board, you have to input standard value of 2mv gap.

And you can check the this 2mV gap value on **F96**. (Normally, the gap value is between 200,000 ~400,000)

5-4. Set-up

Set-up means set the F-function and make SI 4100 weighing controller will perform more accuracy.

(Considering external / internal environmental condition)

※remarks : In case that “P-W” is displayed, you have to check the pass word.

5-4-1. Enter the Set-up Mode

Method : Press  key for 4sec. Then you can enter “F-Test” mode. Under this mode, press No.1 key and enter the “F-function” mode.

5-4-2. F-Function Change

Under F-function mode, Whenever press  key, the Function No. will be increased one by one. Increase to F-90 and return to F-01

If you move to certain function No., press f-function no. with number key and press  key.

Ex) If you want to call “F21-XX ” directly under “F-function mode”.

Press “” and “” key and press  key.

Then, you can call “F22-XX” directly.

5-4-3. F-Function Set Value Change

Under F-Function mode, input New set value with Number keys and press  key to save.

If you don't press  key, the new set value will not be memorized.

Ex) If you want to change the “F01-01” to “F01-02”.

Under “F01-01” mode, press “” and “” key.

And press  key to save.

5-4-4. Exit “F-function” Mode

Under “F-function” mode, press  key, you can move back to “F-Test” mode.

Under “F-Test” mode, press  key once again, you can move back “Stand-by” mode.

5-5. F-Function

■ General Function Setting (“●” Factory default set value)

Weighing Data Save Method Selection (Apply on Accumulated weighing count/weight)			
F01	●	0	Manual Save Mode (Save when “Print” key input)
		1	Automatic Save Mode(Save when Finish relay Output)
		2	Combined Save Mode (Save when “Print” key input or weighing is Finished)
		3	Non-Save Mode(Any kinds of weighing data will not be saved).
Weight-Back up selection			
F02		0	Normal Mode
	●	1	Weight Back up Mode
Motion Band Range setting			
F03	06	00 ┆ 50	<p>This is set “Steady” acceptable range of weighing part.</p> <p>If there is vibration on weighing part, you can set this function and reduce the vibration effect on weighing process.</p> <p>0 : Weak vibration ~ 50 : Strong Vibration</p>
Zero Tracking Compensation Range setting			
F04	02	00 ┆ 09	<p>Due to external causes(Temperature, wind, and dust), there are small weight difference, indicator will ignore the weight difference and display Zero.</p> <p>For this compensation function, indicator will estimate the weight difference is over the set range during fixed time period.</p> <p>If there is large weight difference over set range within fixed time period, the “Zero” is breaking and will find new zero point.</p>
Auto Zero Range setting			
F05	00	00 ┆ 99	<p>Within the “Auto Zero” range, weighing part is steady, indicator will display current weight as “Zero”</p> <p>If the weighing part is not “Steady”, indicator will display current weight.</p> <p>(Auto Zero Range : ± Set value + weight unit)</p>
Digital Filter setting			
F06	13	AB	<p>A : Frequency Filter setting value (0~1) (0 : about 200Hz/sec, 1 : about 500Hz/sec)</p> <p>B : Buffer Filter setting value (1~9)</p> <p>If “B” set value is fixed, “A” set value is large, the indicator will response more sensitive.</p>
Zero /Tare key Operation mode selection			
F07	●	0	Activate when “Steady” condition, only
		1	Always activated

Zero key Operation Range selection					
F08		0	Activated within 2% of Max Capacity		
		1	Activated within 5% of Max Capacity		
	●	2	Activated within 10% of Max Capacity		
		3	Activated within 20% of Max Capacity		
		4	Activated within 50% of Max Capacity		
		5	Activated within 100% of Max Capacity		
		6	Whenever Press “Zero” key (No Limit)		
Tare key Operation Range selection					
F09		0	Activated within 10% of Max Capacity		
		1	Activated within 20% of Max Capacity		
	●	2	Activated within 50% of Max Capacity		
		3	Activated within 100% of Max Capacity		
“Hold” Mode selection					
F10	●	0	Peak Hold : Measure Max weight value and hold on display.		
		1	Sample Hold : Hold current weight until “Hold Reset”.		
External Input Selection					
F11	Set Value	Input 1	Input 2	Input 3	Input 4
	● 0	ZERO	TARE /TARE reset	Hold / Hold reset	PRINT
	1	RUN/STOP	TARE / TARE reset	ZERO	PRINT
	2	RUN	STOP	SUB-Print	GRAND PRINT
	3	STOP	TARE	TARE RESET	PRINT
	4	RUN	STOP	TARE	TARE RESET
	5	RUN	STOP	ZERO	PRINT
	6	Zero	TARE / TARE reset	HOLD	HOLD RESET
“STEADY” condition check time setting					
F12	03	01 ┌ 20	During the set time period, estimate weighing part’s “STEADY” condition and display. If you set small value, indicator will take “STEADY” fast, if you set large value, indicator will take “STEADY” slow.		

Display Up-date rate selection (per sec)			
F13	<input checked="" type="radio"/>	0	238 times
	<input type="radio"/>	1	102 times
	<input type="radio"/>	2	64 times
	<input type="radio"/>	3	47 times
	<input type="radio"/>	4	34 times
	<input type="radio"/>	5	31 times
	<input type="radio"/>	6	26 times
	<input type="radio"/>	7	23 times
	<input type="radio"/>	8	20 times
	<input type="radio"/>	9	18 times
Sp1, Sp2, Sp3, Sp4 Set value apply selection			
F14	<input checked="" type="radio"/>	0	Apply only certain P/N
	<input type="radio"/>	1	Apply same set value to all P/N
Minus(-) symbol display selection			
F16	<input checked="" type="radio"/>	0	Display (-) symbol on the display
	<input type="radio"/>	1	Not use
“NEAR ZERO” relay output mode selection			
F17	<input checked="" type="radio"/>	0	Display weight is Zero → Near Zero relay output
	<input type="radio"/>	1	Only Gross Zero(Net weight + TARE) → Near Zero relay output
Equipment No. setting			
F18	01	01~ 99	Equipment No. setting with No. key. (01 ~99 settable)
“Key Tare” selection			
F19	<input checked="" type="radio"/>	0	Key Tare Not Use
	<input type="radio"/>	1	Key Tare Use

■ Relay Output Mode Setting

Weighing Mode selection							
F21	●	1	Limit Mode 1. (Relay “ON”, when current weight reaches set value)				
		2	Packer Mode				
		3	Check weighing Mode 1.				
		4	Check weighing Mode 2.				
		5	Limit Mode 2. (Relay “OFF”, when current weight reaches set value)				
		6	User’s Choice Relay Output Mode 1. (“B” Dry Contact relay) - User can arrange “Sp1~4” relay output sequence, by setting				
		7	User’s Choice Relay Output Mode 2. (“A” Dry Contact relay) - User can arrange “Sp1~4” relay output sequence, by setting				
		8	Accumulating Mode1				
		9	Packer Mode 2 (User’s Choice relay)				
		10	Accumulating Mode2				
Relay output Mode(Each weighing Mode)							
Weighing Mode		Output1	Output2	Output3	Output4	Output5	Output6
1	Limit Mode 1.	Sp1“ON”	Sp2“ON”	Sp3“ON”	Sp4“ON”	FINISH	Near Zero
2	Packer Mode	Sp1	Sp2	Sp3	Sp4	FINISH	Near Zero
3	Check weighing Mode 1.	Near Zero	Sp1	Sp2	Sp3	Sp4	Near Zero
4	Check weighing Mode 2.	Near Zero	Sp1	Sp2	Sp3	Sp4	Near Zero
5	Limit Mode 2.	Sp1“OFF”	Sp2“OFF”	Sp3“OFF”	Sp4“OFF”	FINISH	Near Zero
6	User’s Choice 1	Sp1“OFF”	Sp2“OFF”	Sp3“OFF”	Sp4“OFF”	FINISH	Near Zero
7	User’s Choice 2	Sp1“ON”	Sp2“ON”	Sp3“ON”	Sp4“ON”	FINISH	Near Zero
8	Accumulating Mode1	SP1 “ON”	SP1+SP2 “ON”	SP1+SP2 +SP3 “ON”	SP1+SP2+SP3 +SP4 “ON”	FINISH	Near Zero
9	Packer Mode-User’s Choice	SP1	SP2	SP3	SP4	FINISH	Near Zero
10	Accumulating Mode2	SP1 “ON”	SP1+SP2 “ON”	SP1+SP2 +SP3 “ON”	SP1+SP2+SP3 +SP4 “ON”	FINISH	Near Zero

◆ Weighing Mode 1. Limit Mode 1. (F21-01 setting) - Relay “ON” when weight reaches to set value

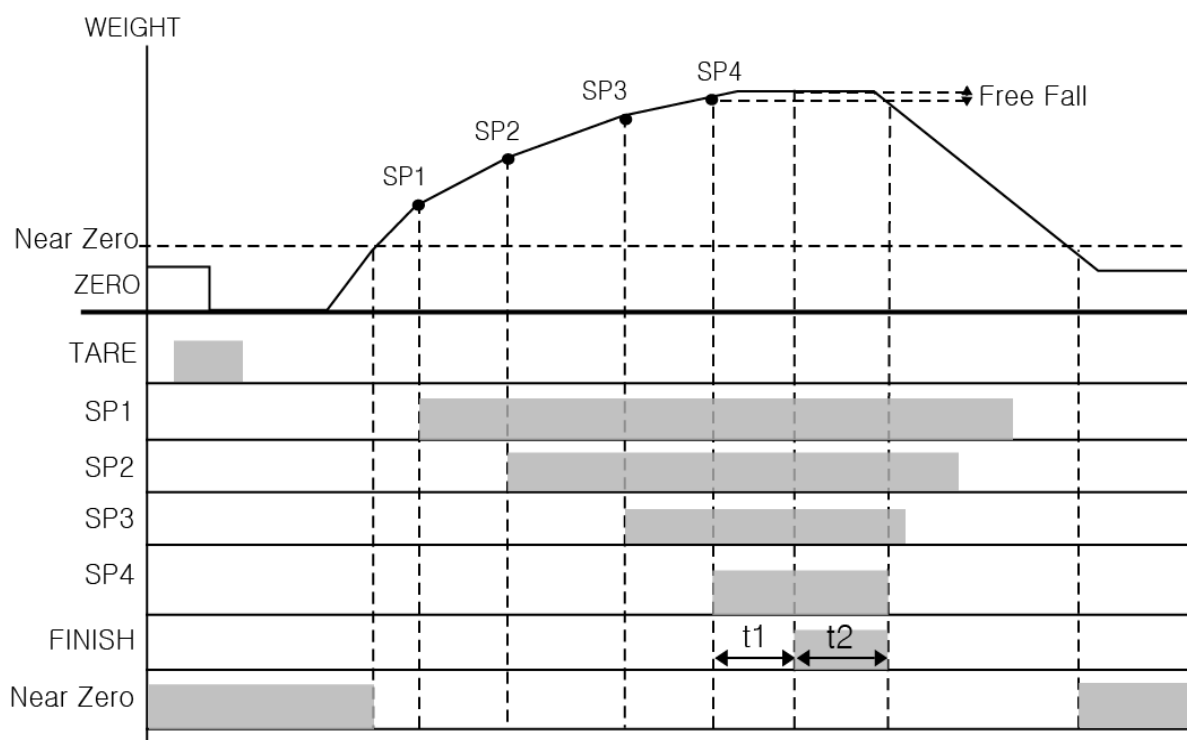

1. Set value setting

Sp1(Bulk), Sp2(Bulk + Drib), Sp3(Bulk + Drib + Fall), Sp4(FINAL)

Setting conditions : (Sp4>Sp3>Sp2>Sp1)

※ If the setting conditions are not satisfied, “E” symbol displayed and you can process the weighing.

2. Finish relay output delay time(t1) setting : F-Function 22

3. Finish relay output “ON” time(t2) setting : F-Function 23

※ **Finish Relay will be “OFF”, after “t2” time set or weight is under “Empty Range”.**

4. Output Relay

Relay	Contents	Relay	Contents
SP 1	Current weight \geq SP1(ON) Current weight $<$ SP1(OFF)	SP4	Current weight \geq SP4(ON) Current weight $<$ SP4(OFF)
SP 2	Current weight \geq SP2(ON) Current weight $<$ SP2(OFF)	FINISH	After “t1” time, “On” during “t2” time
SP3	Current weight \geq SP3(ON) Current weight $<$ SP3(OFF)	Near Zero	Within “EMPTY” range (ON)

◆ Weighing Mode 2. Packer Mode (F21-02 setting)

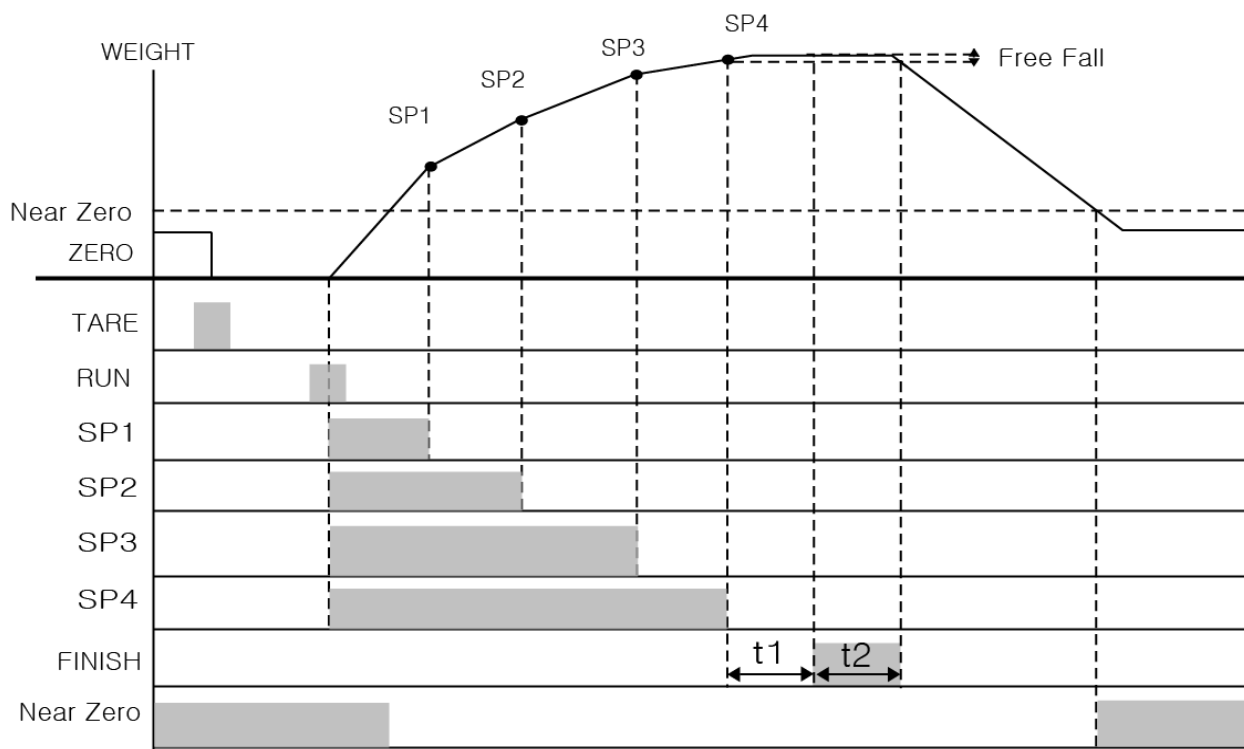

1. Set value setting

Sp1(Bulk), Sp2(Bulk + Drib), Sp3(Bulk + Drib + Fall), Sp4(FINAL)

Setting conditions : (Sp4>Sp3>Sp2>Sp1)

※ If the setting conditions are not satisfied, “E” symbol displayed and you can process the weighing.

2. Finish relay output delay time(t1) setting : F-Function 22

3. Finish relay output “ON” time(t2) setting : F-Function 23

4. Relay Output

Relay	Contents	Relay	Contents
SP 1	RUN input : ON Current weight \geq SP1(OFF)	SP4	RUN input : ON Current weight \geq SP4(OFF)
SP 2	RUN input : ON Current weight \geq SP2(OFF)	FINISH	After “t1” time, “On” during “t2” time
SP3	RUN input : ON Current weight \geq SP3(OFF)	NEAR ZERO	Within “EMPTY” range (ON)

5. “Drib” (F26-01 setting)

◆ Weighing Mode 3. Comparison Mode (F21-03 setting) - Checker Mode 1.

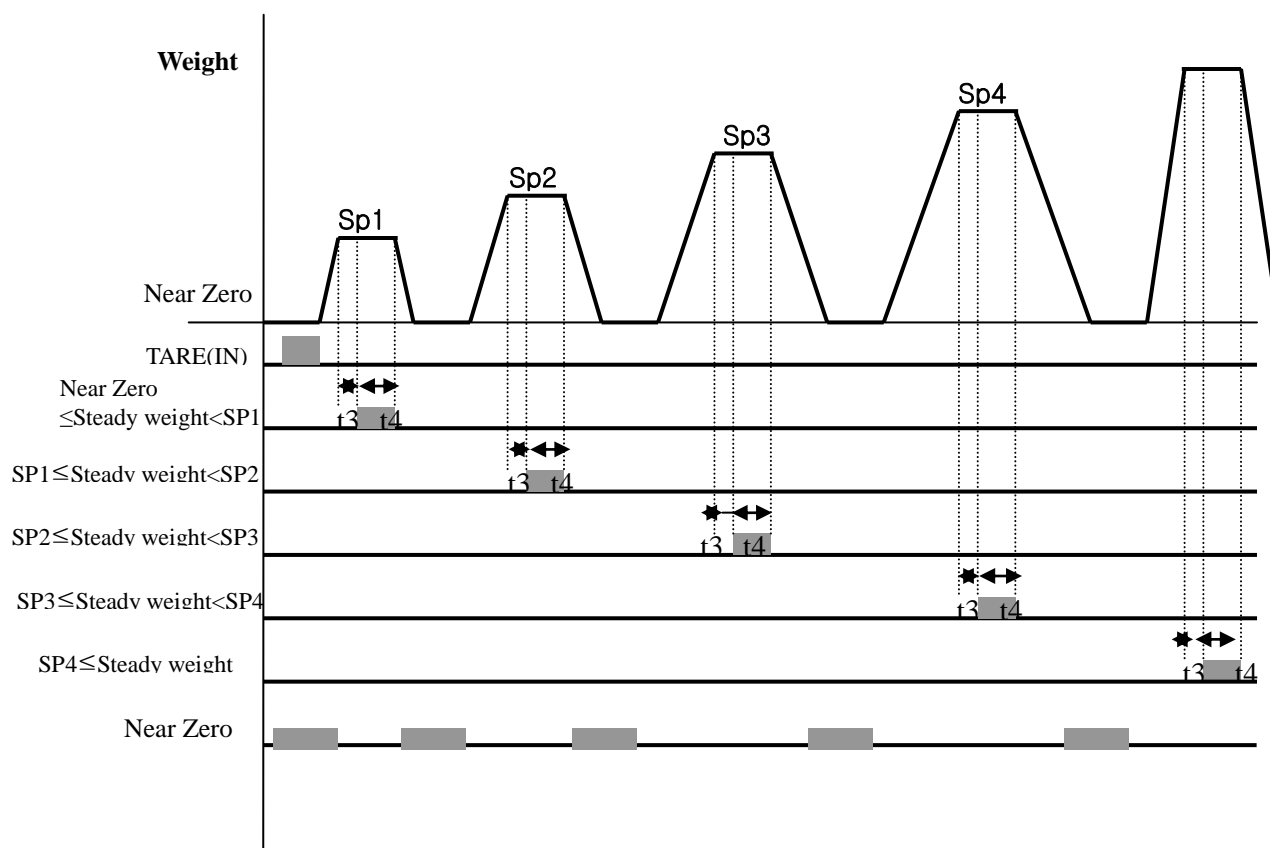

1. Set value setting

Sp1(Acceptable Range), Sp2 (Acceptable Range), Sp3(Acceptable Range), Sp4(Acceptable Range)

2. Each relay will be “ON” within its own acceptable range after “t3”time, during “t4” time.

3. Relay Output

Relay	Contents	Relay	Contents
SP 1	Near Zero < Steady weight ≤ SP1 (ON)	SP4	SP3 < Steady weight ≤ SP4 (ON)
SP 2	SP1 < Steady weight ≤ SP2 (ON)	OVER	SP4 < Steady weight (ON)
SP3	SP2 < Steady weight ≤ SP3 (ON)	NEAR ZERO	Within “EMPTY” range (ON)

◆ Weighing Mode 4. Packer Mode (F21-04 setting) - Checker mode 2.

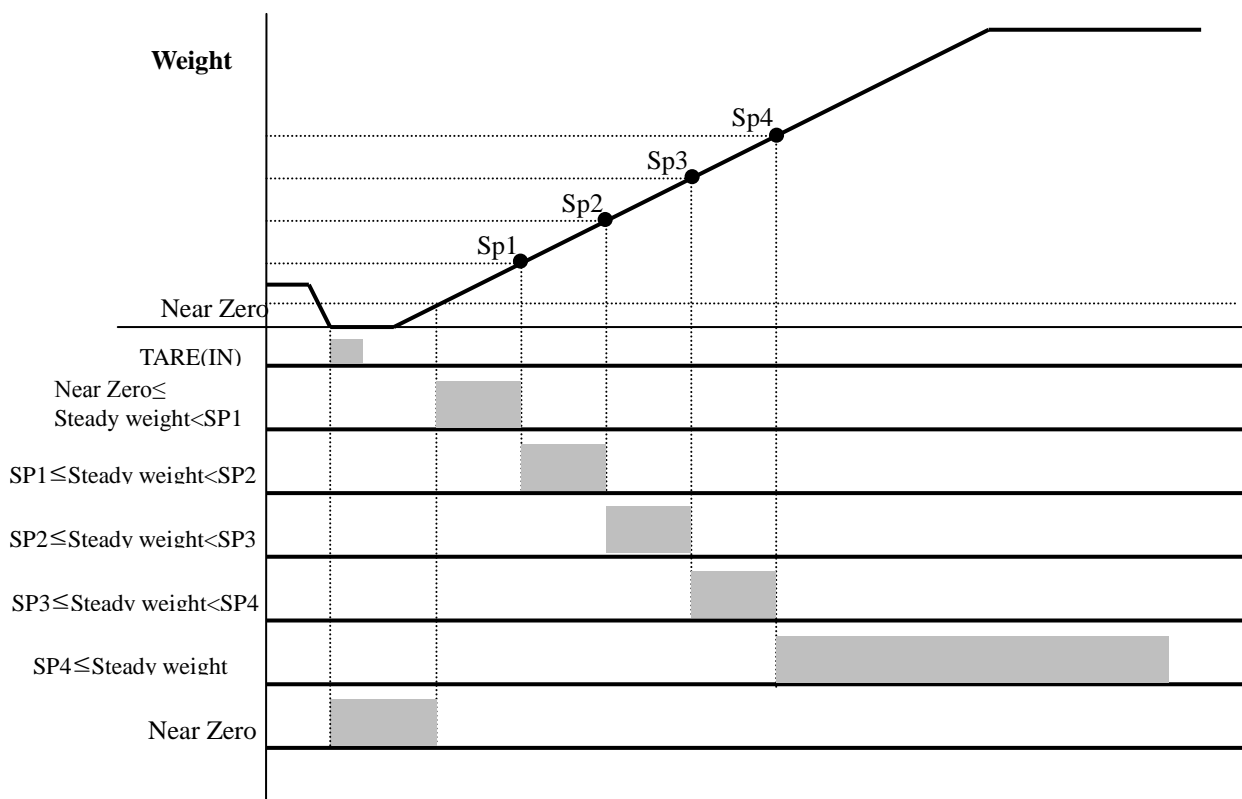

1. Set value setting

Sp1(Acceptable Range), Sp2 (Acceptable Range), Sp3(Acceptable Range), Sp4(Acceptable Range)

2. Each relay will be “ON” within its own acceptable range after “t3”time, during “t4” time.

3. Relay Output

Relay	Contents	Relay	Contents
SP 1	Near Zero < Current weight ≤ SP1 (ON)	SP4	SP3 < Current weight ≤ SP4 (ON)
SP 2	SP1 < Current weight ≤ SP2 (ON)	OVER	SP4 < Current weight (ON)
SP3	SP2 < Current weight ≤ SP3 (ON)	NEAR ZERO	Within “EMPTY” range (ON)

◆ Weighing Mode 5. Limit Mode 2. (F21-05 setting) - Relay “OFF” when weight reaches to set value

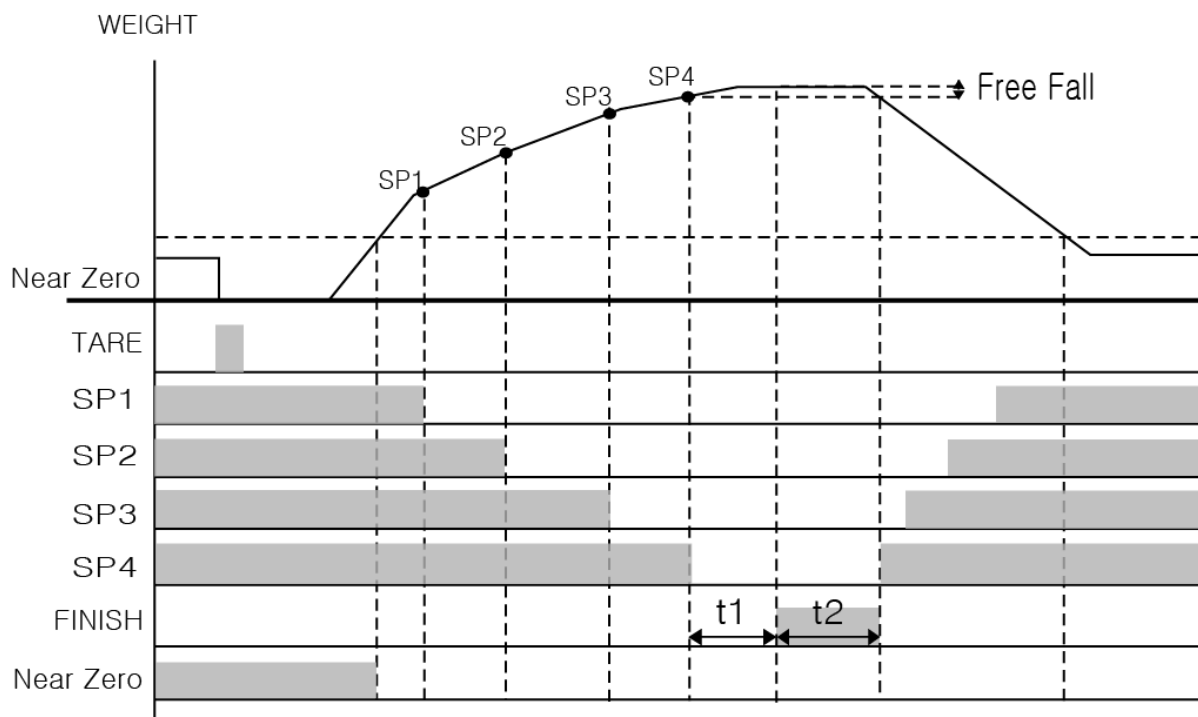

1. Set value setting

Sp1(Bulk), Sp2(Bulk + Drib), Sp3(Bulk + Drib + Fall), Sp4(FINAL)

Setting conditions : (Sp4>Sp3>Sp2>Sp1)

※ If the setting conditions are not satisfied, “E” symbol displayed and you can process the weighing.

2. Finish relay output delay time(t1) setting : F-Function 22

3. Finish relay output “ON” time(t2) setting : F-Function 23

※ **Finish Relay will be “OFF”, after “t2” time set or weight is under “Empty Range”.**

4. Output Relay

Relay	Contents	Relay	Contents
SP 1	Current weight < SP1(OFF) Current weight ≥ SP1(ON)	SP4	Current weight < SP4(OFF) Current weight ≥ SP4(ON)
SP 2	Current weight < SP2(OFF) Current weight ≥ SP2(ON)	FINISH	After “t1” time, “On” during “t2” time
SP3	Current weight < SP3(OFF) Current weight ≥ SP3(ON)	Near Zero	Within “EMPTY” range (ON)

◆ Weighing Mode 6. User's Choice Mode 1. (F21-06 setting)

- User Can arrange each relay output (SP1~4) sequence, by setting each SP value. ("B" Dry Contact)

- Example.

User's Relay output Sequence : SP3→SP1→SP4→SP2→Finish→Near Zero

SP settings : SP3(100kg), SP1(200kg), SP4(300kg), SP2(400kg)

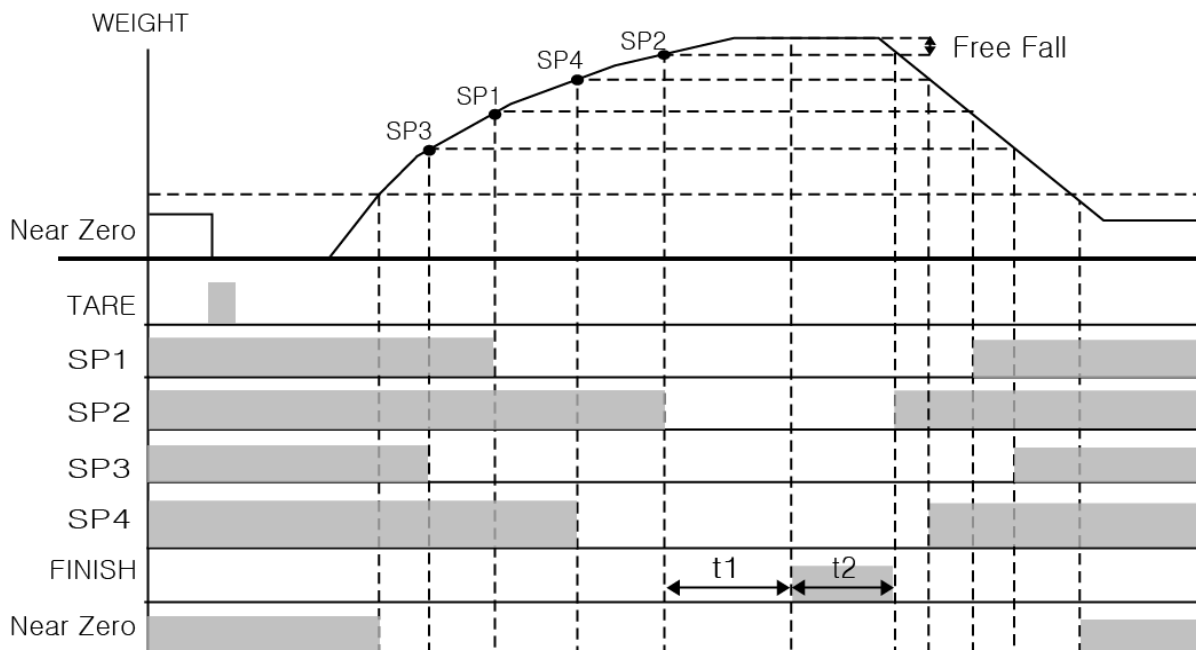

1. Set value setting

SP1, SP2, SP3, SP4 must be bigger than "Empty(Near Zero) Range".

※ If the setting conditions are not satisfied, "E" symbol displayed and you can process the weighing.

2. Finish relay output delay time(t1) setting : F-Function 22

3. Finish relay output "ON" time(t2) setting : F-Function 23

※ Finish Relay will be "OFF", after "t2" time set or weight is under "Empty Range".

4. Output Relay

Relay	Contents	Relay	Contents
SP 1	Current weight < SP1(OFF) Current weight ≥ SP1(ON)	SP4	Current weight < SP4(OFF) Current weight ≥ SP4(ON)
SP 2	Current weight < SP2(OFF) Current weight ≥ SP2(ON)	FINISH	After "t1" time, "On" during "t2" time
SP3	Current weight < SP3(OFF) Current weight ≥ SP3(ON)	Near Zero	Within "EMPTY" range (ON)

◆ Weighing Mode 7. User's Choice Mode 2. (F21-07 setting)

- User Can arrange each relay output (SP1~4) sequence, by setting each SP value. ("A" Dry Contact)

- Example.

User's Relay output Sequence : SP3→SP1→SP4→SP2→Finish→Near Zero

SP settings : SP3(100kg), SP1(200kg), SP4(300kg), SP2(400kg)

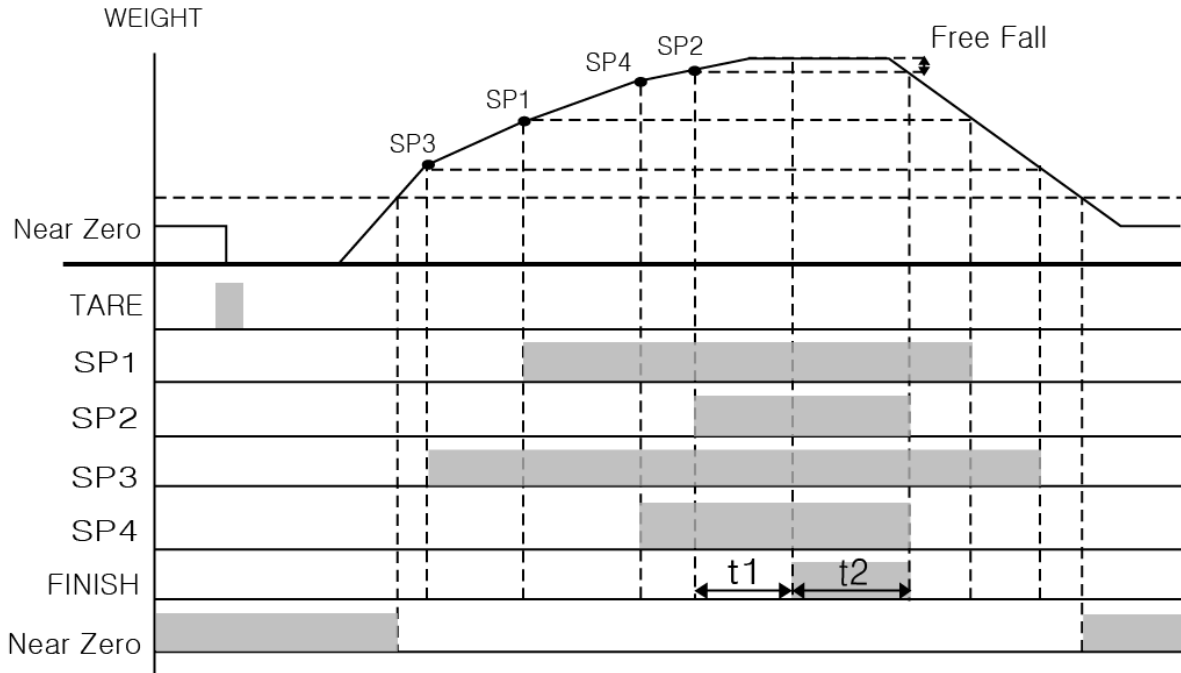

1. Set value setting

SP1, SP2, SP3, SP4 > "Empty(Near Zero) Range.

※ If the setting conditions are not satisfied, "E" symbol displayed and you can process the weighing.

2. Finish relay output delay time(t1) setting : F-Function 22

3. Finish relay output "ON" time(t2) setting : F-Function 23

※ Finish Relay will be "OFF", after "t2" time set or weight is under "Empty Range".

4. Output Relay

Relay	Contents	Relay	Contents
SP 1	Current weight \geq SP1(ON) Current weight $<$ SP1(OFF)	SP4	Current weight \geq SP4(ON) Current weight $<$ SP4(OFF)
SP 2	Current weight \geq SP2(ON) Current weight $<$ SP2(OFF)	FINISH	After "t1" time, "On" during "t2" time
SP3	Current weight \geq SP3(ON) Current weight $<$ SP3(OFF)	Near Zero	Within "EMPTY" range (ON)

◆ Weighing Mode 8 Accumulating Mode 1 (F21-08 Setting)

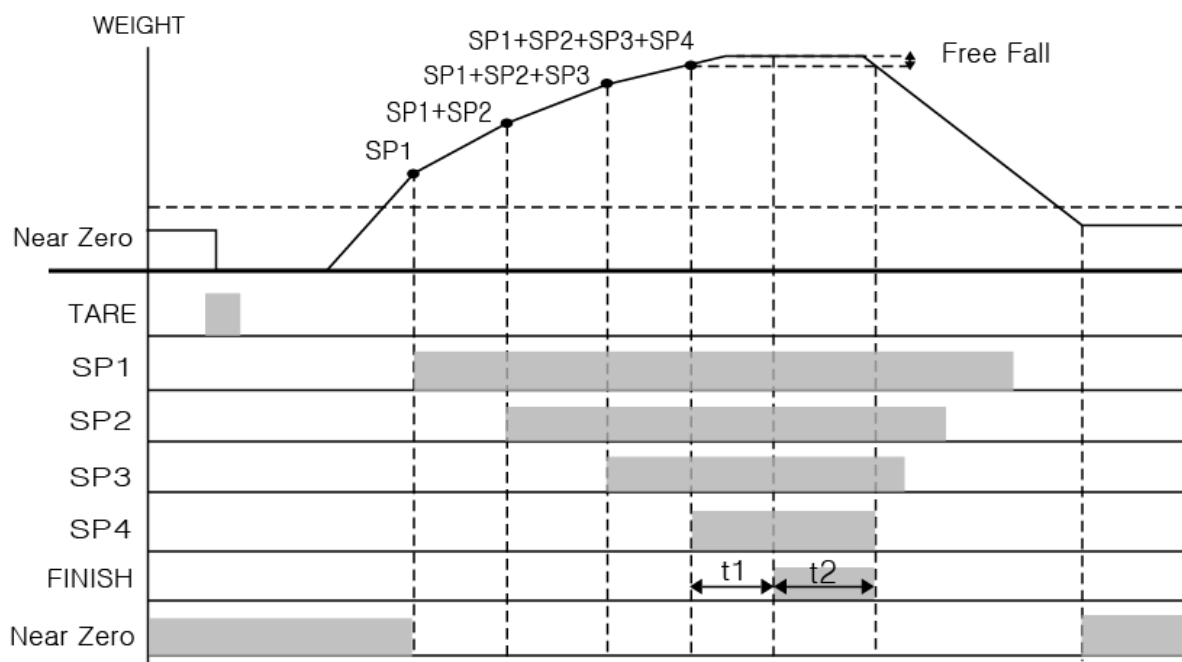

1. Set Value Setting

SP1, SP2, SP3, SP4 > “Empty(Near Zero) Range.

※ **SP1, SP2, SP3, SP4 = 0**, The relay is not used.

Sp1(No.1 Material Set value), Sp2(No.2 Material Set value), Sp3(No.3 Material Set value), Sp4(No.4 Material Set value) **There is any condition to set the each set value.**

※ **Control Relay output type**

- **SP1 Relay “ON”** = Current Weight = SP1 Set value
- **SP2 Relay “ON”** = Current Weight = SP1 + SP2 Set value
- **SP3 Relay “ON”** = Current Weight = SP1 + SP2 + SP3 Set value
- **SP4 Relay “ON”** = Current Weight = SP1 + SP2 + SP3 + SP4 Set value

2. Finish relay output delay time(t1) setting : F-Function 22

3. Finish relay output “ON” time(t2) setting : F-Function 23

※ **Finish Relay will be “OFF”, after “t2” time set or weight is under “Empty Range”.**

4. Output Relay

Relay	Contents	Relay	Contents
SP 1	Current weight ≥ SP1(ON) Current weight < SP1(OFF)	SP4	Current weight ≥ SP1+SP2+SP3+SP4(ON) Current weight < SP1+SP2+SP3+SP4(OFF)
SP 2	Current weight ≥ SP1+SP2(ON) Current weight < SP1+SP2(OFF)	FINISH	After “t1” time, “On” during “t2” time
SP3	Current weight ≥ SP1+SP2+SP3(ON) Current weight < SP1+SP2+SP3(OFF)	Near Zero	Within “EMPTY” range (ON)

◆ Weighing Mode 9. Packer mode User's Choice 2 (F21-09 Setting)

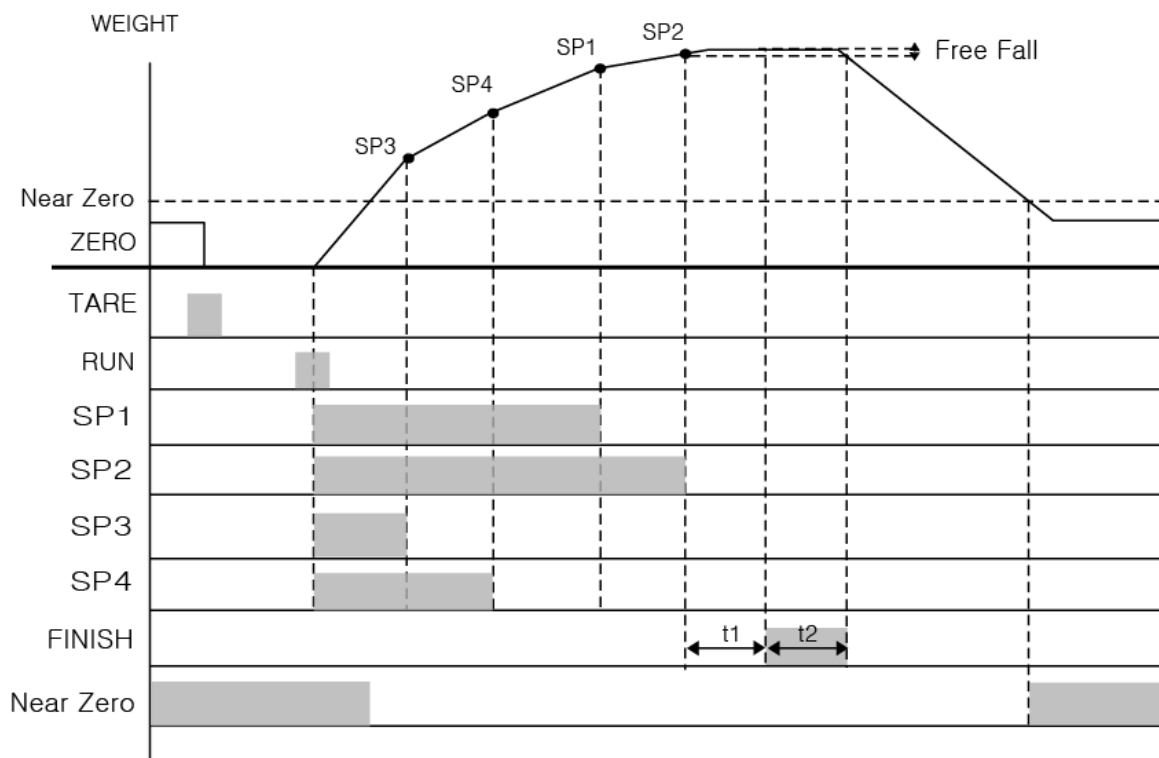

1. SP1, SP2, SP3, SP4 can be any value.

※ SP1, SP2, SP3, SP4 = 0, The relay is not used.

2. Finish relay output delay time(t1) setting : F-Function 22

3. Finish relay output “ON” time(t2) setting : F-Function 23

※ Finish Relay will be “OFF”, after “t2” time set or weight is under “Empty Range”.

4. Relay Output

Relay	Contents	Relay	Contents
SP 1	RUN input : ON Current weight = SP1(OFF)	SP 4	RUN input : ON Current weight = SP4(OFF)
SP 2	RUN input : ON Current weight = SP2(OFF)	FINISH	After time “t1”, “On” during time “t2”
SP 3	RUN input : ON Current weight = SP3(OFF)	Near Zero	Within “EMPTY” range (ON)

5. “Drib” (F26-01 setting)

◆ Weighing Mode 10 Accumulating Mode 2 (F21-10 Setting)

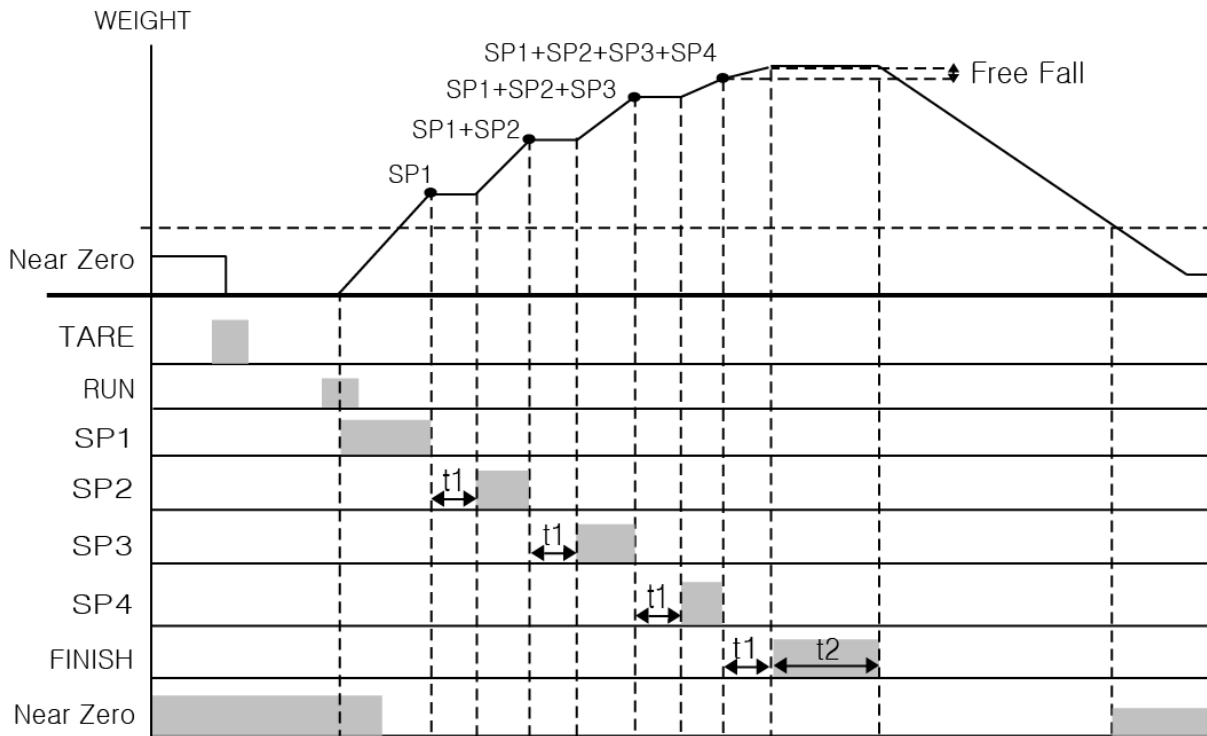

1. SP1, SP2, SP3, SP4 can be any value.

※ SP1, SP2, SP3, SP4 = 0, The relay is not used.

2. Finish relay output delay time(t1) setting : F-Function 22

3. Finish relay output “ON” time(t2) setting : F-Function 23

※ Finish Relay will be “OFF”, after “t2” time set or weight is under “Empty Range”.

4. Relay Output

Relay	Contents	Relay	Contents
SP 1	Current weight < SP1(ON)	SP 4	SP1+SP2+SP3 < Current weight < SP1+SP2+SP3+ SP4(ON)
SP 2	SP1< Current weight <SP1+SP2(ON)	FINISH	After time “t1”, “On” during time “t2”
SP 3	SP1+SP2 < current weight < SP1+SP2+SP3 (ON)	Near Zero	Within “EMPTY” range (ON)

“FINISH Relay” delay time(t1) setting (Under F21- 01, 02, 05 setting)			
F22	10	00 ┆ 99	<p>After current weight is reached to FINAL, you can set some delay time of “FINISH relay ON time.</p> <p>“00” setting : At Steady point, FINISH relay output “20” setting : After 2.0sec from Steady point, FINISH relay output “99” setting : After 9.9sec from Steady point, FINISH relay output</p>
FINISH Relay “ON” time(t2) setting (Under F21-01, 02, 05 setting)			
F23	10	00 ┆ 99	<p>You can set duration time for FINISH relay.</p> <p>“00” setting : during before Empty, FINIFH relay output “01” setting : FINISH relay will be “ON during 0.1sec. “20” setting : FINISH relay will be “ON” during 2.0sec.</p>
“STEADY” Judging delay time(t3) setting (Only for F21-03, Check mode1.)			
F24	10	00 ┆ 99	<p>After current weight is reached to each set point, you can set some delay time of “STEADY”.</p> <p>“00” setting : At Steady point, FINISH relay output “20” setting : During 2.0sec, hold “Steady” relay “99” setting : During 9.9sec, hold “Steady” relay</p>

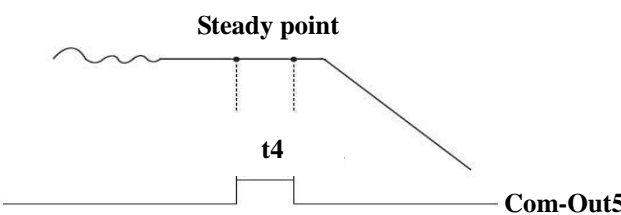
“STEADY” Judging “ON” time(t4) setting (Only for F21-03, Check mode1.)			
F25	10	00 ┆ 99	<p>You can set duration time for Error relay</p>  <p>“01” setting : ERROR relay will be “ON during 0.1sec. “20” setting : ERROR relay will be “ON” during 2.0sec.</p>
“DRIB” Control Apply selection (Only for F21-02, F21-09)			
F26	<input checked="" type="radio"/>	0	Not use
	<input type="radio"/>	1	Use
Weight Mode selection			
F27	<input checked="" type="radio"/>	0	Absolute weight weighing mode
	<input type="radio"/>	1	Positive weight weighing mode
Manual Discharge selection (Only for F21-02, Packer mode)			
F28	<input checked="" type="radio"/>	0	Not use
	<input type="radio"/>	1	Use

■ **Communication Mode setting (Serial Port 1. - Standard installed port)**

Parity Bit selection Mode			
F30	<input checked="" type="radio"/>	0	No Parity
	<input type="radio"/>	1	Odd Parity
	<input type="radio"/>	2	Even Parity
Serial Communication Speed selection			
F31	<input type="radio"/>	0	2,400bps
	<input type="radio"/>	1	4,800bps
	<input checked="" type="radio"/>	2	9,600bps
	<input type="radio"/>	3	14,400bps
	<input type="radio"/>	4	19,200bps
	<input type="radio"/>	5	28,800bps
	<input type="radio"/>	6	38,400bps
	<input type="radio"/>	7	57,600bps

		8	76,800bps
		9	115,200bps
DATA Transference Method selection			
F32	<input checked="" type="radio"/>	0	Simplex Mode / Stream Mode
	<input type="radio"/>	1	Duplex Mode / Command Mode
Print port selection (Under F32-01 setting, only)			
F33	<input checked="" type="radio"/>	0	Same port as using for Command Mode.
	<input type="radio"/>	1	The other port.
“Check-Sum” detection selection (Under F32-01 setting, only)			
F34	<input checked="" type="radio"/>	0	Check-Sum data will not be included on transferred data.
	<input type="radio"/>	1	Check-Sum data will be included on transferred data.
Serial Port Application Selection (Under F32-00 setting, only)			
F35	<input checked="" type="radio"/>	0	DATA Transference purpose
	<input type="radio"/>	1	Printing purpose (Serial Printer)
DATA Transference Mode selection (Under F32-00, F35-00 setting, only)			
F36	<input checked="" type="radio"/>	0	Stream Mode : Weighing Data will be transferred continuously.
	<input type="radio"/>	1	Finish Mode : When Finish Relay output, only 1 time transferred.
	<input type="radio"/>	2	Manual Mode : When “Print” key input, 1 time transferred.
DATA Transference Format selection(Under F32-00, F35-00 setting, only)			
F37	<input checked="" type="radio"/>	0	Format 1.
	<input type="radio"/>	1	Format 2. (Format 1 + ID No.)
	<input type="radio"/>	2	CAS Format
	<input type="radio"/>	3	AND Format
Print Mode selection (Under F32-00, F35-01 setting, only)			
F38	<input checked="" type="radio"/>	0	Manual Print : Whenever “Print” key input.
	<input type="radio"/>	1	Auto Print : When Finish relay output, automatically print.
Transferred Weight DATA Byte selection			
F40	<input checked="" type="radio"/>	0	7 Byte data Transfer
	<input type="radio"/>	1	8 Byte data Transfer

■ Print Mode Setting (These settings will be apply to Serial and Parallel print)

Weight Unit selection			
F41	<input checked="" type="radio"/>	0	kg
	<input type="radio"/>	1	g

		2	t
Print Format selection (If you install on Standard Serial Port)			
F42	<input checked="" type="radio"/>	0	Continuous Print : Serial No. and Weight will be printed continuously.
	<input type="radio"/>	1	Single Print : Date, Time, S/N, ID No. Weighing Data will be print
Print Format selection (If you install on Optional Serial Port)			
F43	<input checked="" type="radio"/>	0	Continuous Print - Serial No. and Weight will be printed continuously.
	<input type="radio"/>	1	Single Print - Date, Time, S/N, ID No. Weighing Data will be print
SUB/GRAND Total Data Delete selection			
F44	<input checked="" type="radio"/>	0	Manual Delete Mode SUN Total Delete : “Clear” key + “P/N” key GRAND Total Delete : “Clear” key + “S/N” key
	<input type="radio"/>	1	Automatic Delete Mode After SUB/GRAND Total Print, Automatically Deleted.
Paper Withdraw Rate setting (After SUB/GRAND Total Print)			
F45	03	01~09	Whenever set value increased, 1line will be added.
Paper Withdraw Rate setting (After Continuous/Single Print)			
F46	03	01~09	Whenever set value increased, 1line will be added.
Printing Language Selection (If you install on Standard Serial Port)			
F47	<input checked="" type="radio"/>	0	KOREAN
	<input type="radio"/>	1	ENGLISH
Printing Language Selection (If you install on Optional Serial Port)			
F48	<input type="radio"/>	0	KOREAN
	<input checked="" type="radio"/>	1	ENGLISH
Minus(-) symbol Print selection			
F49	<input checked="" type="radio"/>	0	Print minus(-) symbol, if the weight is minus(-).
	<input type="radio"/>	1	Ignore minus(-) symbol
Parallel Print Port selection			
F50	<input checked="" type="radio"/>	0	Parallel Port is not installed.
	<input type="radio"/>	1	Share Standard Serial Port.
	<input type="radio"/>	2	Share Optional Serial Port.
Function / Clear key Activation display selection			
F51	<input type="radio"/>	0	Activation display not use
	<input checked="" type="radio"/>	1	Activation display use
Communication Interval Setting			
F52	<input checked="" type="radio"/>	0	Fast Speed (The interval is short)
	<input type="radio"/>	1	Low Speed (The interval is long)

Analogue Output Selection (Under 4~20mA Option Card Installed)			
F53	●	0	20mA Output, When Display weight is same as Max Capacity
		1	20mA Output, When Display weight is same as SP1 set value
		2	20mA Output, When Display weight is same as SP2 set Value
		3	20mA Output, When Display weight is same as SP3 set value
		4	20mA Output, When Display weight is same as SP4 set Value
Analogue Output Setting (4~20mA / Option)			
F54	●	0	Positive Output (Max Capacity : 20mA output)
		1	Negative Output (Max Capacity : 4mA output)
Setting Using Pass word or not (F95 : Set the pass word and change)			
F55	●	0	Using
		1	Not Used
Protocol Frame Transit Setting			
F56	●	0	Not Used
		1	Using (When connecting protocol with an appliance which uses frame by frame.)
Caution : When setting Command frame, if F53(protocol frequency) is high the speed of system can be slow. In this case, please set F53-01.			
BCD INPUT Type Setting (Refer to Interface BCD INPUT)			
F57	●	0	Input the units digit & the tens digit one by one. (1,2,4,8)(1,2,4)
		1	Input the units digit & the tens digit together

■ **Other Setting**

※ Under “Other setting mode”, you can not move to other function directly.

EMPTY Range setting		
F80	X.X.X.X.X. (0.0.0.0.1.0)	You can set “EMPTY” Range. Within set range, indicator will not display current weight and just display “Zero”. “0.000” setting : When Net Zero, “Zero” status lamp and Near Zero relay will be output. “0.190” setting : Within 190, “Zero” Status lamp and Near Zero relay will be output.
Minimum Analog Output Setting		
F81	Minimum analog output value is able to adjust to be 4mA or 0V. (Minimum value is 0) Number key ‘1’ : Move to left, ‘2’ : Move to right, ‘3’ : Increase value	
Maximum Analog Output Setting		
F82	Maximum analog output value is able to adjust to be 20mA or 10V. (Maximum value is 65536) Number key ‘1’ : Move to left, ‘2’ : Move to right, ‘3’ : Increase value	

SPAN Calibration Value Check	
F89	<p>X.X.X.X.X.X.</p> <p>Span Calibration Value Check</p> <p>Under F-function mode, enter “ 8 SP3 ”, “ 9 SP4 ” key and press “ CLEAR ”.</p> <p>After checking the value and press “ CLEAR ” to exit</p> <p>※ If you have difficulty to process Calibration again, the best way to matching the net weight and display weight is doing Calibration process once again.</p>
DATE Check / Change	
F90	Check Current DATE data or you can Change to new date
TIME check / Change	
F91	Check Current TIME data or you can Change to new date
Set the pass word and change	
F95	<p>You can set the pass word and change it.</p> <p>How to set : When “P-W” is displayed ,input the password .</p> <p>1) If “1” display, input password (4 numbers)</p> <p>2) If “2” display, recheck the password</p> <p>“0000” is saved as basic password.</p> <p>When setting password you cannot start “SETUP” mode without password, do not forget your password.</p>
Program & Hard ware Version Check	
F98	Check the Program & Hard ware version (H/W : X.XX, S/W : X.XX.X)
Production DATE Check	
F99	Check the Product’s Production Year and Month.

■ Communication Mode setting (Serial Port 2. - Optional Serial port)

Parity Bit selection Mode					
F60	●	0	DATA Bit (8 Bit)	STOP Bit (1 Bit)	Parity Bit (Non)
		1	DATA Bit (7 Bit)	STOP Bit (2 Bit)	Parity Bit (Non)
		2	DATA Bit (7 Bit)	STOP Bit (1 Bit)	Parity Bit (Even)
		3	DATA Bit (7 Bit)	STOP Bit (1 Bit)	Parity Bit (Odd)
		4	DATA Bit (8 Bit)	STOP Bit (2 Bit)	Parity Bit (Non)
		5	DATA Bit (8 Bit)	STOP Bit (1 Bit)	Parity Bit (Even)
		6	DATA Bit (8 Bit)	STOP Bit (1 Bit)	Parity Bit (Odd)

Serial Communication Speed selection			
F61		0	2,400bps
		1	4,800bps
	●	2	9,600bps
		3	14,400bps
		4	19,200bps
		5	28,800bps
		6	38,400bps
		7	57,600bps
		8	76,800bps
		9	115,200bps
DATA Transference Method selection			
F62	●	0	Simplex Mode / Stream Mode
		1	Duplex Mode / Command Mode
Print port selection (Under F62-01 setting, only)			
F63	●	0	Same port as using for Command Mode.
		1	The other port.
“Check-Sum” detection selection (Under F62-01 setting, only)			
F64	●	0	Check-Sum data will not be included on transferred data.
		1	Check-Sum data will be included on transferred data.
Serial Port Application Selection (Under F62-00 setting, only)			
F65	●	0	DATA Transference purpose
		1	Printing purpose (Serial Printer)
DATA Transference Mode selection (Under F62-00, F65-00 setting, only)			
F66	●	0	Stream Mode : Weighing Data will be transferred continuously.
		1	Finish Mode : When Finish Relay output, only 1 time transferred.
		2	Manual Mode : When “Print” key input, 1 time transferred.
DATA Transference Format selection(Under F62-00, F65-00 setting, only)			
F67	●	0	Format 1.
		1	Format 2. (Format 1 + ID No.)
		2	CAS Format
Print Mode selection (Under F62-00, F65-01 setting, only)			
F68	●	0	Manual Print : Whenever “Print” key input.
		1	Auto Print : When Finish relay output, automatically print.

6. INTERFACE

6-1. Serial Interface (RS-232C)

RS-232C Serial Interface is sensitive/weak for electric Noise.

So, please isolate with AC power cable and use shield cable to reduce the electric noise effect.

6-1-1. Communication with PC(Personal Computer) or Other devices

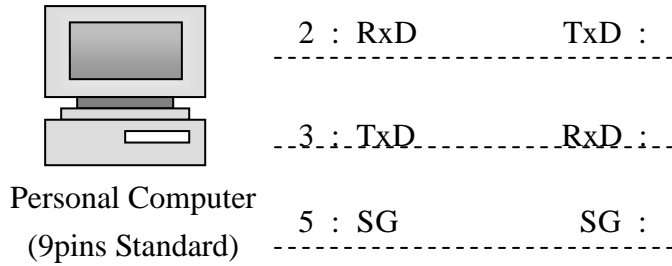

SI 4100

6-1-2 Connection with External Display or other devices

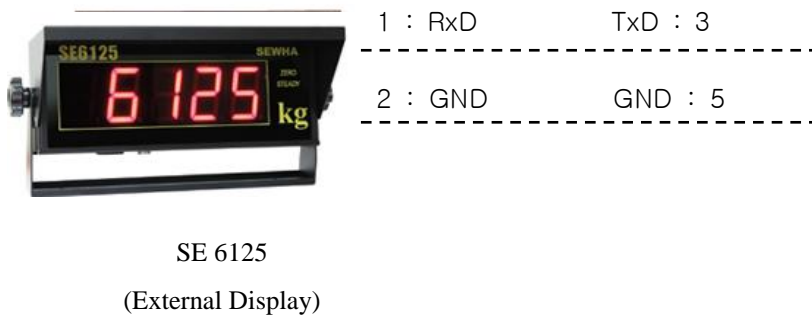

SI 4100

6-1-3. Signal Format

- ① Type : EIA-RS-232C
- ② Communication Method : Half-Duplex, Full Duplex, Asynchronous
- ③ Serial Baud Rate : Selectable on “F-function31”
- ④ Data Bit : 8(No Parity mode, only)Bit – Refer “F30”.
- ⑤ Stop Bit : 1
- ⑥ Parity Bit : Non, Even, Odd (Selectable on “F-function 30”) - Refer “F30”
- ⑦ Code : ASCII
 - STX 02H
 - ETX 03H
 - CR 0DH
 - LF 0AH
- ⑧ Check-Sum (Error Detecting, “F-Function 34”)

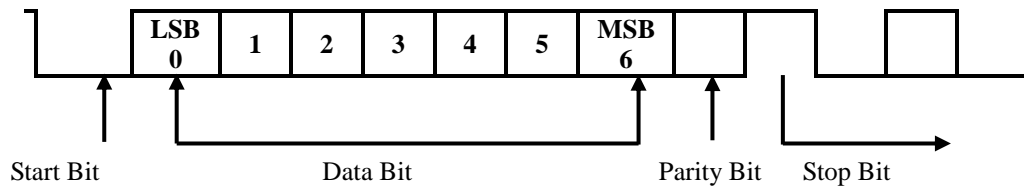

6-1-4 Data Format(1) : ID Number will not be transferred. (Refer “F-function 37”)

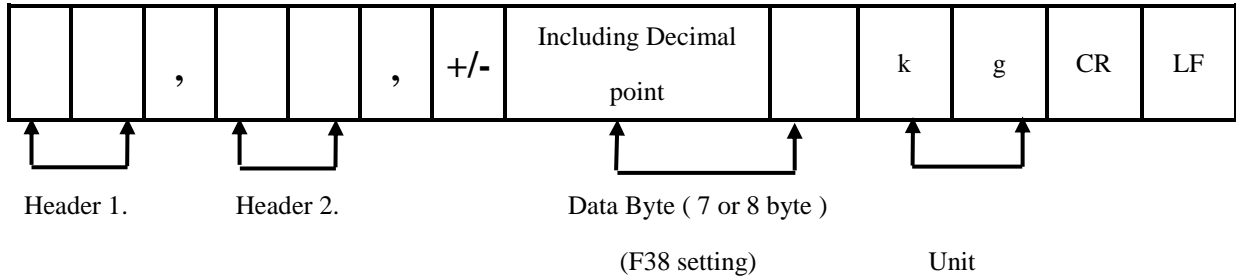

- ① Header 1. : OL : Over Load, Under Load
ST : Display weight “Steady”
US : Display “Un-Steady”
- ② Header 2. : NT : Net-Weight
GS : Net-Weight, under TARE
- ③ Data Bit(Number) 2B(H) : “+” Plus
2D(H) : “-“ Minus
2D(H) : “ ” Space
2E(H) : “.” Decimal Point
- ④ Unit : kg, g, t

6-1-5 Data Format(2) : ID Number + Data Transference (Refer “F-function 18, 37”)

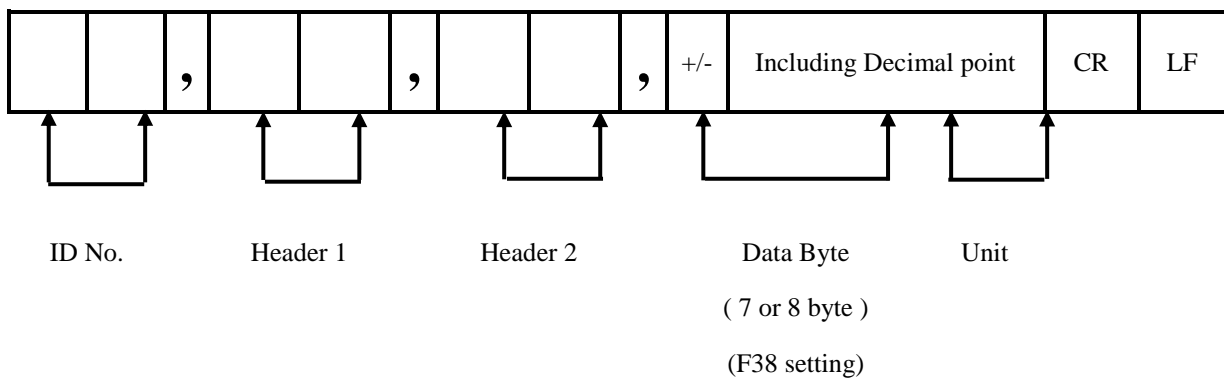

- ① Header 1. : OL : Over Load, Under Load
ST : Display “Steady”
US : Display “Un-Steady”

② Header 2. : NT : Net-Weight

GS : Net-Weight, under TARE.

③ Data Bit(Number) 2B(H) : “+” Plus

2D(H) : “-“ Minus

2D(H) : “ “ Space

2E(H) : “.” Decimal Point

④ Unit : kg, g, t

6-1-6 Data Format(3) : CAS “CI5101A” Data Transference) – CAS 22byte Format

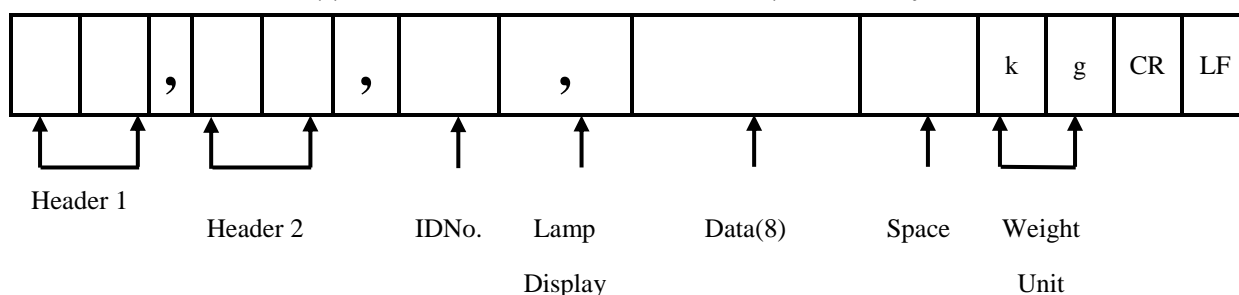

① Header 1. : OL : Over Load, Under Load

ST : Display “Steady”

US : Display “Un-Steady”

②. Header 2. : NT : Net-Weight

GS : Net-Weight, under TARE.

③ Lamp Display : Current Lamp Condition (ON/Off Data)

Bit 7	Bit 6	Bit 5	Bit 4	Bit 3	Bit 2	Bit 1	Bit 0
1	Steady	1	Hold	Print	Gross Weight	Tare	Zero

④ Data Bit(Number) 2B(H) : “+” Plus

2D(H) : “-“ Minus

2D(H) : “ “ Space

2E(H) : “.” Decimal Point

⑤ Unit : kg, g, t

6-1-7. Data Format : AD – 4321 Data Transference) – AD – 4321 18byte Format

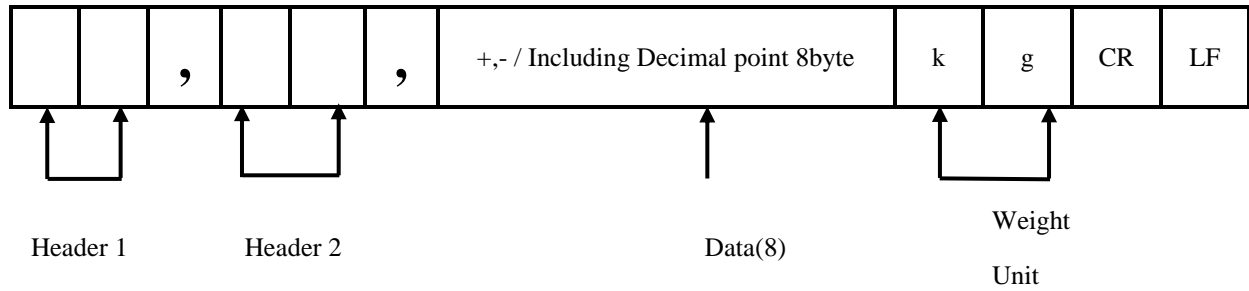

- ① Header 1. : OL : Over Load, Under Load
 ST : Display “Steady”
 US : Display “Un-Steady”
- ② Header 2. : NT : Net weight (Under Tare)
 GS : Net weight (Under TARE reset)
- ③ Data Bit(Number) 2B(H) : “+” Plus
 2D(H) : “-“ Minus
 20(H) : “ “ Space
 2E(H) : “.” Decimal Point
- ④ Unit : Kg, g, t

6-2. Current Loop Interface

“Current Loop” Interface is stronger for Electric Noise than “RS-232C” interface.

So, it can be used for long distance communication.(About 100m long distance).

※ **Current Loop Interface supports, up to 9,600 Communication Speed, only.**

6-2-1. Communication with Other Devices (Remote Display / External Display)

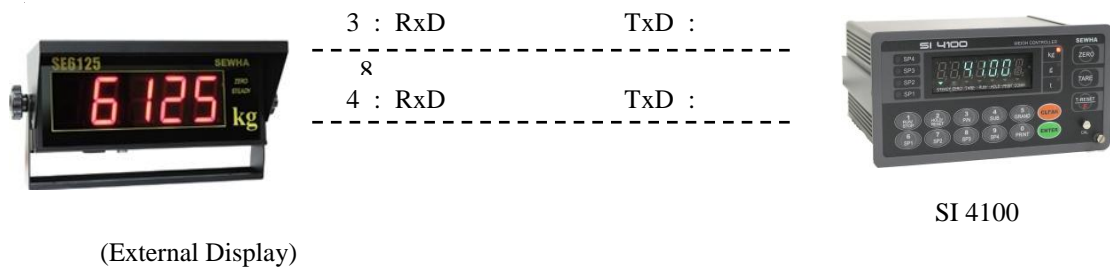

6-2-2. Current Loop Circuit

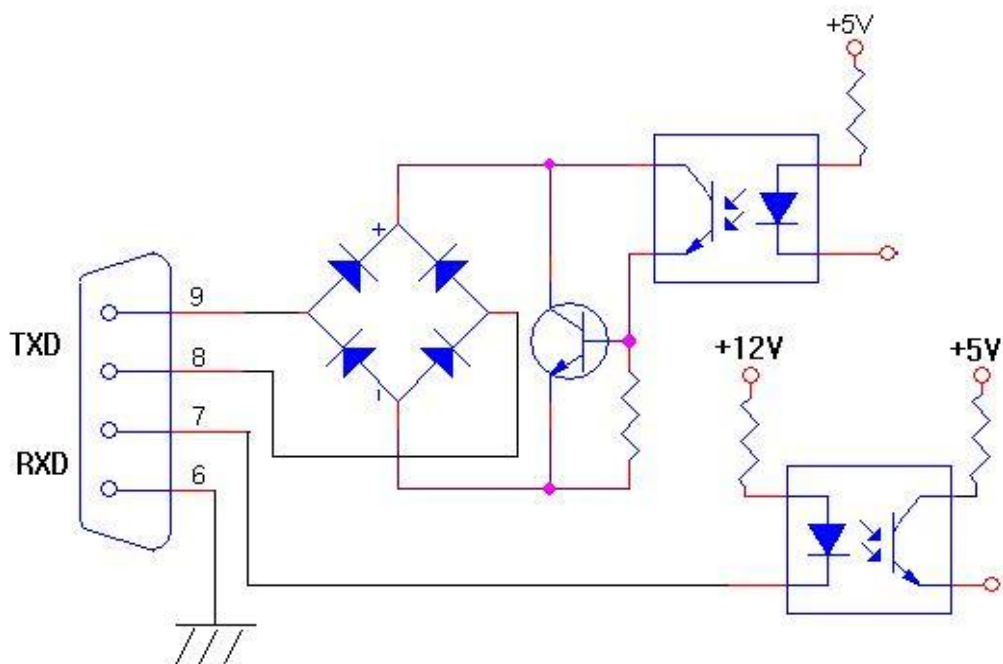

6-2-2. Data Format

As same as “RS-232C” Interface

6-3. Print Interface (Option 01 : Centronics Parallel Interface)

This Print Interface Option is based on “Centronics Parallel Interface”, so this print interface can be connected other printers using this communication method.

But, the print format is programmed based on our “SE7300”, and “SE7320” Industrial Printers, so you had better to use these printer for convenience.

6-3-1. Connector Wire Connection

Pin	Signal	Contents	RE
1	STROBE	STROBE signal	out
2	DATA0	Data(bit0) signal	out
3	DATA1	Data(bit1) signal	out
4	DATA2	Data(bit2) signal	out
5	DATA3	Data(bit3) signal	out
6	DATA4	Data(bit4) signal	out
7	DATA5	Data(bit5) signal	out
8	DATA6	Data(bit6) signal	out
9	DATA7	Data(bit7) signal	out
10	ACK	Data Response	In
11	BUSY	Busy signal	In
12,13	N.C		

Pin	Signal	Contents	RE
14	N.C		
15	N.C		
16	N.C		
17	N.C		
18	GND	GROUND	out
19	GND	GROUND	out
20		GROUND	out
21		GROUND	out
22		GROUND	out
23		GROUND	out
24		GROUND	out
25	GND	GROUND	out

6-3-2 Print Format (English)

Single Print Format

DATE : 2006-10-15			
TIME : 10:20:30			
ID_N	PART	SERIAL	WEIGHT
01	10	33	+ 1.000 kg
DATE : 2006-10-15			
TIME : 10:21:30			
ID_N	PART	SERIAL	WEIGHT
01	10	34	+ 1.000 kg
DATE : 2006-10-15			
TIME : 10:22:30			
ID_N	PART	SERIAL	WEIGHT
01	10	35	+ 1.000 kg

Continuous Print format

Date : 2006-10-15			
Time : 10:20:30			
ID_N	PART	SERIAL	WEIGHT
01	10	33	+ 1.000 kg
01	10	34	+ 1.000 kg
01	10	35	+ 1.000 kg
01	10	36	+ 1.000 kg
01	10	36	+ 1.000 kg
01	10	37	+ 1.000 kg
01	10	38	+ 1.000 kg
01	10	40	+ 1.000 kg
01	10	41	+ 1.000 kg
01	10	42	+ 1.000 kg
01	10	43	+ 1.000 kg

Sub-Total Print Format

SUB-TOTAL	
DATE :	2006-10-15
TIME :	10:30:30
ID_N :	01
PART:	10
T-COUNT :	2
T-WEIGHT :	2.000kg

Grand-Total Print Format

GRD-TOTAL		
DATE :	2006-10-15	
TIME :	10:40:30	
ID_N :	01	
PART	SERIAL	WEIGHT
10	2	2.000kg
T-PART :	1	
T-COUNT :	2	
T-WEIGHT :	2.000kg	

6-4. Analog Output Interface (Option 02 : 0~10V Output)

This Option card converts weight value to Analog Voltage output(0~10V) and transfers to external devices(Recorder, P.L.C), controlled by voltage output.

6-4-1. Specification

- ① Output Voltage : 0~10V DC output
- ② Accuracy : More than 1/1,000

6-4-2. Circuit

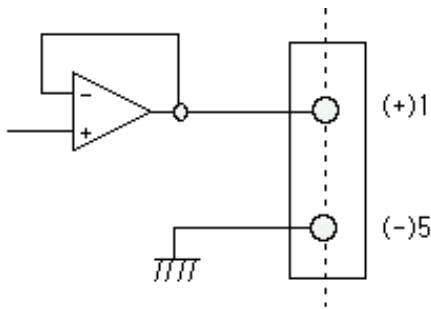

※ This Voltage output is proportioned on weight calibration and outputs 0~10V.

6-4-3. Output Adjustment

- ① This output is adjusted as when the weight is “Zero”, output is 0V and When the weight is “Full capacity”, output is 10V.
- ② If you need additional adjustment, please adjust with “VR1(Zero)”, “VR2(Span) on the Analog Output PCB.

※ Remark

This Analog option card converts Displayed weight value(Micro-process data) to analog value on D/A Converter(Digital to Analog converter)

This D/A Converter has Max 1/4,000 accuracy, so this output is not suitable for high accuracy application, like more than 1/3,000.

6-4-4. Connector (9pin, “D-type” female)

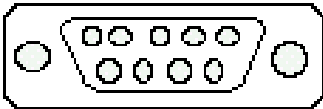
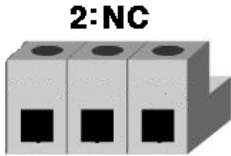
9 pin D-type connector(Female)	Terminal Block (3 pin)
 <p>1 : HI(+), 5 : (-)</p>	 <p>2: NC 1: HI (+) 3: (-)</p>

※ For 0~5VDC or 1~5VDC analog output, please inform when you inquiry.

6-5. Analog Output Interface (Option 03 : 4~20mA Output)

This Option card converts weight value to Analog Electric Current output(4~20mA) and transfers to external devices(Recorder, P.L.C), controlled by electric current output.

6-5-1. Specification

- ① Output Current : 4~20mA (Output Range : 2~22mA)
- ② Accuracy : More than 1/1,000
- ③ Temperature Co-efficiency : 0.01% °C
- ④ Max Loaded Impedance : Max 500Ω

※ When Weight display is “Zero”, 4mA current will be output, when Weight display is “Full Capacity”, 20mA current will be output.

6-5-2. Circuit

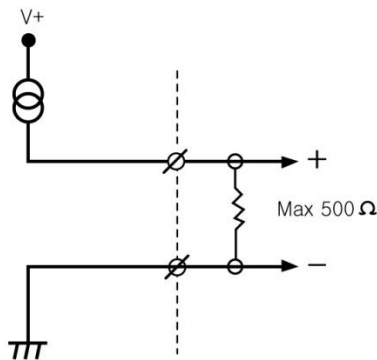

※ “LO” terminal is not a “GND”, so this “LO” terminal do not be connected with other “GND” terminal on other devices.

6-5-3. Output Adjustment

- ① This output is adjusted as when the weight is “Zero”, output is “4mA” and When the weight is “Full capacity”, output is “20mA”.
- ② If you need additional adjustment, please adjust with “VR1(Zero)”, “VR2(Span)” on the Analog Output PCB.

※ Remark

This Analog option card converts Displayed weight value(Micro-process data) to analog value on D/A Converter(Digital to Analog converter)

This D/A Converter has Max 1/4,000 accuracy, so this output is not suitable for high accuracy application, like more than 1/3,000.

6-5-4. Connector (9pin, “D-type” female)

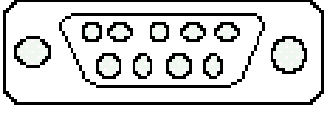
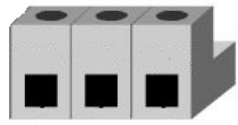
9 pin D-type connector(Female)	Terminal Block (3 pin)
 <p>1 : HI(+), 5 : (-)</p>	 <p>2: NC 1: HI(+) 3: (-)</p>

6-6. Serial Interface (option 04 : RS-232C/422/485)

RS-422/485 serial interface is more stable for electric noise effect compare with other communication method, using electric current difference.

But, install isolated place from Power cable or other electric cables and wires, and please use shielded cable for better performance.

Recommendable communication distance is about 1.2km.

If you install additional RS-232C interface, please refer “6-1. Serial Interface” section.

6-6-1. Signal Format

- ①. Type : RS-422/485
- ②. Format : Baud Rate : Refer “F-function 31”.

Data Bit : 7 or 8(No Parity)

Stop : 1

Parity Bit : Even, Odd, No Parity (Selectable)

Code : ASCII (STX 02H, ETX 03H, CR 0DH, LF 0AH)

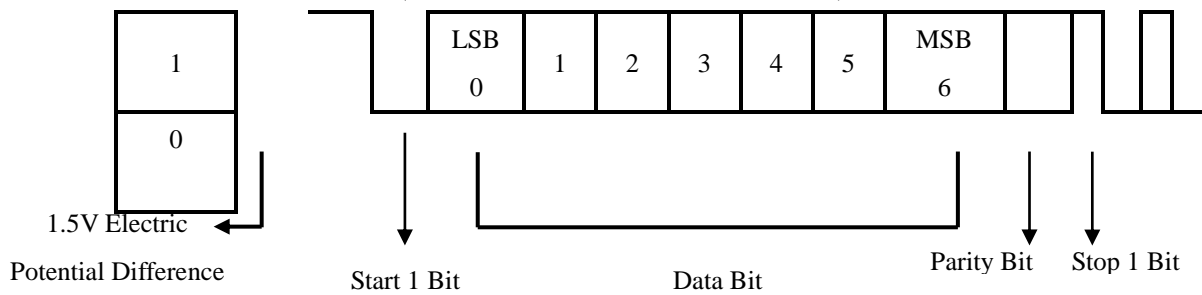

6-6-2. Data Format

Same as RS-232C (Refer “6-1. Serial Interface”)

6-6-3. RS-485 Circuit (In case of RS-485, only Use No6 and 7 pin)

D-SUB 9 pin In case of RS -232 : “6-1. Refer to Serial Interface ” In case of RS-485 : only Use No6 and 7 pin		Terminal Block		
Terminal Block	1	2	3	4
RS-232	TX	RX	GND	GND
RS-485	RTX+	RTX-	NC	NC
RS-422	RXD+	RXD-	TXD+	TXD-

6-7. BCD Input (Option 05) – Input for Part No. selection.

This “BCD interface” option card can be applied on PLC (Programmable Logic Controller), or Score Board applications. (NPN TYPE)

Each Input circuit is isolated with “Photo-Coupler”, from external devices electrically.

F57-00 setting

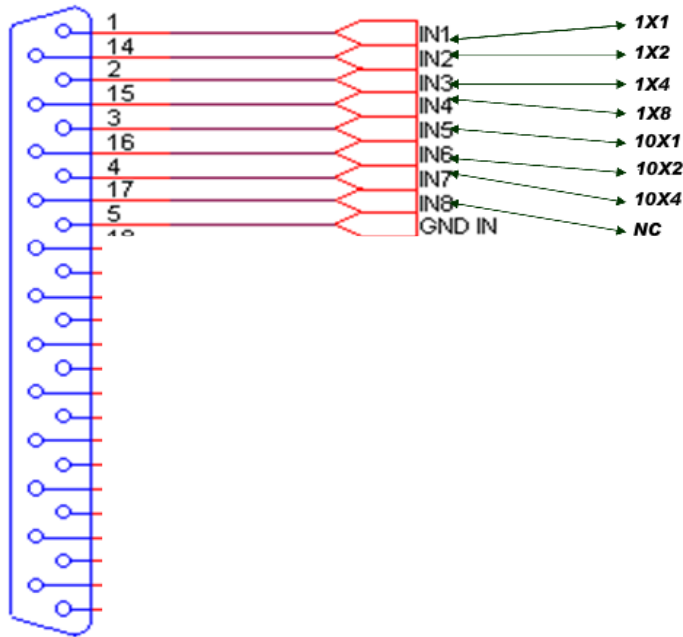

F57-01 setting

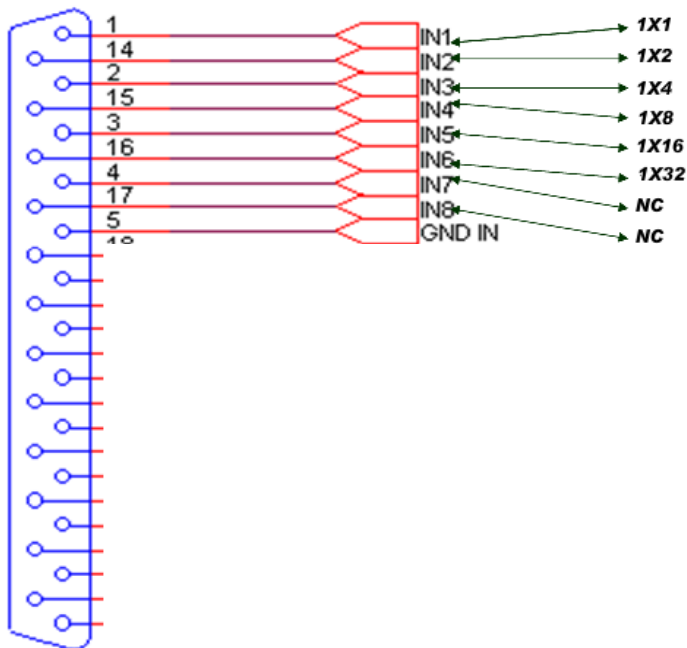

6-8. BCD Output Interface(Option 06)

This “BCD interface” option card can be applied on PLC (Programmable Logic Controller), or Score Board applications.

Each Input circuit is isolated with “Photo-Coupler”, from external devices electrically.

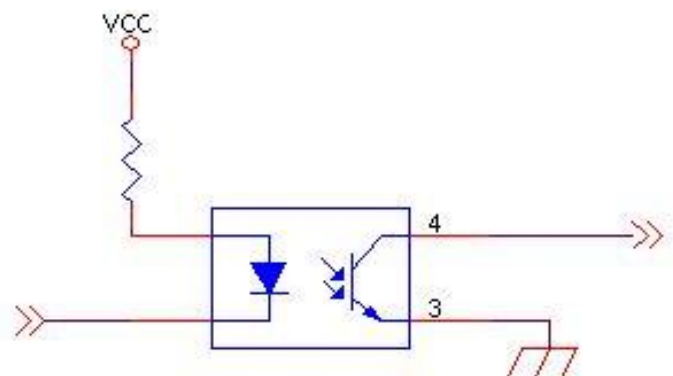
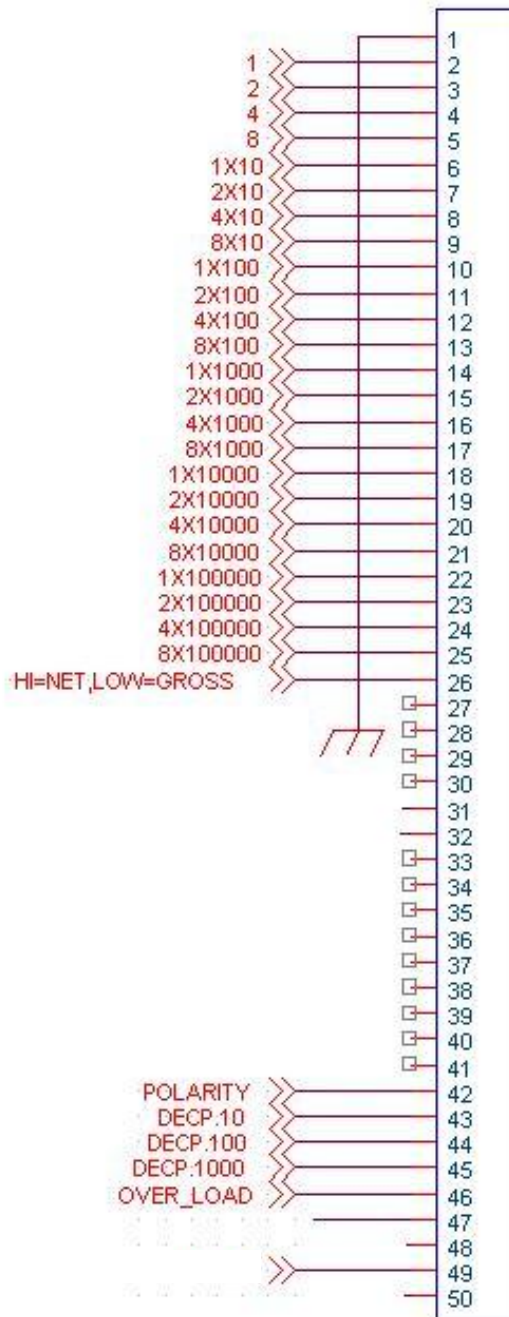

F-function setting for BCD OUT			
F - No.	Set value	F - No.	Set value
F30	0	F60	0
F31	2	F61	2
F32	0	F62	0
F33	0	F63	0
F34	0	F64	0
F35	0	F65	0
F36	0	F66	0
F37	0	F67	0
F38	0		

6-9. Command Mode

Under “Command Mode”, Indicator will recognize the receipt of Order based on 02h(Header) and 03h(END) signal, and transfers ACK(06)/ NAK(15).

6-9-1. Read Command (Standard Serial Port and Optional Port is same.)

P.C ->> SI 4100	Command	SI 4100 Response
STX ID NO. RCWT ETX	Current Weight	Current Weight Transfer -STX ID NO. RCWT ST,NT+/-Current Weight(7/8byte) Weight unit(2byte)ETX
STX ID NO. RCWD ETX	Indicator Memory	Indicator Memory data Transfer -STX ID NO. RCWD DATE(6byte) TIME(6byte) P/N(2byte) S/N(6byte) TARE(7/8byte) current weight(7/8byte) weight unit(2byte) ETX
STX ID NO. RSUB ETX	SUB-Total Data	SUB-Total Data Transfer -STX ID NO. RSUB P/N(2byte) Accumulated Count(6byte) Accumulated Weight(11byte) Weight unit(2byte) ETX
STX ID NO. RGRD ETX	GRAND Total Data	GRAND Total Data Transfer -STX ID NO. RGRD P/N(2byte) Accumulated Count(6byte) Accumulated Weight(11byte) Weight unit(2byte) ETX
STX ID NO. RSNO ETX	S/N Data (Accumulated data)	S/N Data Transfer(For Current P/N) -STX ID NO. RSNO Accumulated Count(6byte) ETX
STX ID NO. RFIN ETX	Finished Weight	Finished Weight Data Transfer -STX ID NO. RFIN Finished Weight(7/8byte) ETX
STX ID NO. RTIM ETX	Current Time Data	Current Time Data Transfer -STX ID NO. RTIM Current Time(6byte) ETX
STX ID NO. RDAT ETX	Current Date Data	Current Date Data Transfer -STX ID NO. RDAT Current Date(6byte) ETX
STX ID NO. RTAR ETX	TARE Data	TARE Data Transfer -STX ID NO. RTAR TARE Data(7/8byte) ETX
STX ID NO. RSP1 ETX	SP1 Set value	SP1 Set value Data Transfer -STX IN NO. RSP1 Set value(7/8byte) ETX
STX ID NO. RSP2 ETX	SP2 Set value	SP2 Set value Data Transfer -STX IN NO. RSP2 Set value(7/8byte) ETX
STX ID NO. RSP3 ETX	SP3 Set value	SP3 Set value Data Transfer -STX IN NO. RSP3 Set value(7/8byte) ETX

STX ID NO. RSP4 ETX	SP4 Set value	SP4 Set value Data Transfer -STX IN NO. RSP4 Set value(7/8byte) ETX
STX ID NO. RPNO ETX	P/N data	P/N Set value Data Transfer -STX IN NO. RPNO P/N Set value(2byte) ETX
STX ID NO. RWRS ETX	Current Indicator situation (weight, relay output)	Current indicator value transmit(including decimal point 7/8byte)- STX ID NO. RWRS current +/- (1byte) current weight(7/8byte),input situation(4byte),relay output(6byte).ETX

6-9-2. Write Command

P.C ->> SI 4100	Command	SI 4100 Response
STX ID NO. WZER ETX	To make Current Weight as Zero	ACK or NAK
STX ID NO. WTAR ETX	TARE	ACK or NAK
STX ID NO. WTRS ETX	TARE Reset	ACK or NAK
STX ID NO. WPRT ETX	Print	ACK or NAK
STX ID NO. WSPR ETX	SUB-Total Print	ACK or NAK
STX ID NO. WGPR ETX	GRAND Total Print	ACK or NAK
STX ID NO. WSTC ETX	Delete SUB-Total Data	ACK or NAK
STX ID NO. WGTC ETX	Delete GRAND-Total Data	ACK or NAK
STX ID NO. WSTR ETX	RUN	ACK or NAK
STX ID NO. WSTP ETX	STOP	ACK or NAK
STX ID NO. WTIM Time Data(6byte) ETX	TIME Setting	ACK or NAK
STX ID NO. WDAT Date Data(6byte) ETX	DATE Setting	ACK or NAK
STX ID NO. WSP1 SP1 data(7/8byte) ETX	SP1 Setting	ACK or NAK
STX ID NO. WSP2 SP2 data(7/8byte) ETX	SP 2 Setting	ACK or NAK
STX ID NO. WSP3 SP3 data(7/8byte) ETX	SP 3 Setting	ACK or NAK
STX ID NO. WSP4 SP4 data(7/8byte) ETX	SP 4 Setting	ACK or NAK
STX ID NO. WPNO Part No. Data(2byte) ETX	P/N Change	ACK or NAK

● How to Calculate Check sum.

Sum the value from “STX” to “ETX” and converts to ASCII(2byte) and transfer.

Convert the Sum value(HEX) to ASCII and transmit(28byte) .

ex) The sum HEX value from STX to ETX(02,30,31,52,43,57,54,03) is 1A6h.

Then, divide 1A6h by 100h(1A6h/100h). the rest of result is A6h.

Calculated remainder value is A6h, then convert A6h to ASCII, 41(A), 36(6), and transfer.

7. Error & Treatment

7-1. Load Cell Installation

Error	Cause	Treatment	Remark
Weight Value is unstable	1. Load cell broken 2. Load cell isolation resistance error 3. Weighing part touches other devices or some weight is on the weighing part 4. Summing Board Error	1. Measure input/output resistance of Load cell. 2. Measure Load cell isolation resistance 3. Check attach point with other devices.	1. Input Resistance of "EXC+" and "EXC-" is about $400\Omega \pm 30$ 2. Output Resistance of "SIG+" and "SIG-" is about $350\Omega \pm 3.5$ 3. Isolate Resistance is more than $100M\Omega$
Weight Value is increased regular rate, but not return to "Zero"	1. Load cell Error 2. Load cell connection Error	1. Check Load cell connection 2. Measure Load cell Resistance	
Weight Value is increased to under Zero	Load cell Output wire (SIG+, SIG-) is switched	Make wire correction	
"UN PASS" display	Load cell broken or Indicator connection Error	Load cell Check Load cell connection Check	
	Power was "ON" when some weight is on the load cell?	Remove weight on the Load cell	
"OL" or "UL" display	1. Load cell broken or Indicator connection Error 2. Loading over than Max Capa.	1. Load cell Check 2. Load cell connection Check 3. Remove over loaded weight	

7-2. Calibration Process

Error	Cause	Treatment
Err 01	When Maxcapacity/digit value is over 20,000	Re-input the Max Capacity, less than 20,000 (Max Capacity / Digit)
Err 04	Standard weight value is over than Max Capa	Re-input Standard weight value with Number keys, under Max Capacity
Err 05	Standard weight value is less than 10% of Max Capa	Re-input Standard weight value with Number keys, more than 10% of Max Capacity
Err 06	1. Amp. Gain is too big 2. Sig+ and Sig- wire connection error 3. Test weight is not loaded	Check standard weight's weight with set value. If there is difference between set value and real weight, please re-input the value (set value is too small)
Err 07	1. Amp. Gain is too small 2. Sig+ and Sig- wire connection error 3. Test weight is not loaded	Check standard weight's weight with set value. If there is difference between set value and real weight, please re-input the value (set value is too big)
Err 08	Under "F-function" model, set value is "N.A"	Check the correct value and re-input
Err A	When there is continuous vibration on the weighing part,, indicator can not process calibration any more.	- Find vibration cause and remove - Load cell check - Load cell cable and connecting condition check

7-3. Digital Weighing Indicator

Error No.	Display	Cause	Treatment
No.1	“CELL- Er” or “--OL--”	1. Load cell Error 2. Load cell cable Error 3. Load cell connection Error 4. A/D Board Error 5. It displays under 5000 or over 520000.	1. Under “TEST” mode 1, check analogue value. If you can not get any analogue value or there is no change although adding load, please check load cell, load cell cable, connection conditions first. 2. Replace another load cell, and check the indicator condition. If you have same problem, please replace new indicator and check A/D board error.
No.2	“Un- Pass”	1. Power is ON, when some materials are on weighing part. ※ Under “Normal Mode”, if there are more than 20% loading of Max capacity, “Un-Pass” display will be appeared and indicator will stay until removing the load. ※ Setting Back-up mode it can memory empty value, and it becomes set value without displaying “Un-pass”)	1. If you set “Normal Mode”, please check weighing part empty or not before turn on the power. If there are some materials in/on weighing part, please remove those materials and turn on the power. 2. Please try to set F02-01(Back-up) mode so that the indicator can remember first empty value. ※ Under “UNPASS”, please press  key, then you can exit the mode you are.
No.3	“FN- SET”	1. When “FN-Memory” is defected 2. When the “FN-Memory” is empty.	1. Please contact the distributor or Head Office.
No.4	“P-Err”	Under Parallel Printer is connected and installed. 1. Parallel printer interface is defected or disconnected.	1. Please check connection of the print cable. 2. Please check the trouble of print. ※ If you only install “Parallel Print” option card, you can check to do.

※ Under “CELL-Er”, Relay will not be Output, and Analogue Output(4~20mA/0~10V), either.

7-4. Indicator Test mode

Through this “Test Mode”, you can check basic conditions of Indicator. This Test consist with total 7 tests.

7-4-1. Enter “Test Mode”



Press  key for 4sec, then display will show “F-Test”.

Under this display, press No.2 key and enter the “Test Mode”.

Under “Test Mode”, please choose each test and check the basic conditions of Indicator.



If you want to exit from each “Test Mode”, press  key.

7-4-2. Test Mode

Test Mode	Contents
Test 1. Analogue Value Test	Under “TEST” display, press No.1 key and Enter “TEST1” mode. Under this mode, you can check the A/D value. If the A/D value is unstable, or there is no change although pressing or loading some force on/in weighing part, please check load cell, load cell, cable, connector, A/D board.
Test 2. Key test	Under “TEST” display, press No.2 key and Enter “TEST2” mode. Press each key, and check the pressed key is operated.
Test 3. Output Relay Test	Under “TEST” display, press No.3 key and Enter “TEST3” mode. This Test will be operated automatically from Relay1 to Relay6. ※ This test will operate automatically, so please remove all materials in/on weighing parts. If you cannot remove materials, please remove relay terminals.
Test 4. External Input Test	Under “TEST” display, press No.4 key and Enter “TEST4” mode. If you press External input S/W, the External S/W No. will be displayed. If the S/W No. is not displayed, please check connecting condition.
Test 5. Communication Test (Com. Port 1)	Under “TEST” display, press No.5 key and Enter “TEST5” mode. After connecting No.2 and 3 pin of 9pin connector, you can test communication condition, like TXD or RXD/TXD. If there is an error in communication, “232-Err” will be displayed with 3times buzzer sound. The communication is working properly, “232Pass” will be displayed with one time buzzer sound.
Test 6. Communication Test (Com. Port 2)	Under “TEST” display, press No.6 key and Enter “TEST6” mode. After connecting No.2 and 3 pin of 9pin connector, you can test communication condition, like TXD or RXD/TXD. If there is an error in communication, “232-Err” will be displayed with 3times buzzer sound. The communication is working properly, “232Pass” will be displayed with one time buzzer sound.
Test 7. BCD IN Test	This test is for “BCD Input”. If you install “BCD IN” option card, you can test this option card operation through this Test mode.

WARRANTEE CERTIFICATION		
<p>This product is passed “Sewhacnm”’s strict quality test.</p> <p>If there is defect of manufacturing or abnormal detection within warrantee period, please contact our Agent or Distributor with this Warrantee certificate.</p> <p>Then, we will repair or replace free of charge.</p>		
WARRANTEE CLAUSE		
<p>1. The Warrantee period, we can guarantee, is one(1) year from your purchasing date</p> <p>2. Warrantee Exception Clause</p> <ul style="list-style-type: none"> - Warrantee period is expired. - Any kinds of Mal-function or defection caused by Modification or Repair without Sewhacnm’s permission. - Any kinds of Mal-function, Defection, or External damage, caused by operator - Any kinds of Mal-function, Defection, caused by using spare part from Non-Authorized Distributor or Agent. - Any kinds of Mal-function, Defection, caused by not following Warnings or Cautions mentioned on this manual. - Any kinds of Mal-function, Defection caused by “Force Majeur”, like Fire, Flood. - Without presentation of this “Warrantee Certification”. <p>3. Other</p> <ul style="list-style-type: none"> - Any kinds of “Warrantee Certification” without authorized Stamp is out of validity 		
<p>Manufacturer : SEWHACNM Co.,Ltd. #504, 302Dong, 397, Seokcheon-ro, Ojeong-gu, Bucheon-si, Gyeonggi-do, Korea Tel : +82 70) 4754 6140 Fax :+82 32) 624 0065 sales@sewhacnm.co.kr http://www.sewhacnm.co.kr Made in KOREA</p>	Product	Digital Weighing Indicator
	Model	SI 4100
	Serial No.	
	AUTHORIZED STAMP	